

S
M
I
T
T
H

CARL J.
1923 ← 1995

MARY C.
1926 ← 1995

GO1M2412



SUSAN COVEY

FEB. 5, 1918 - NOV. 22, 1994

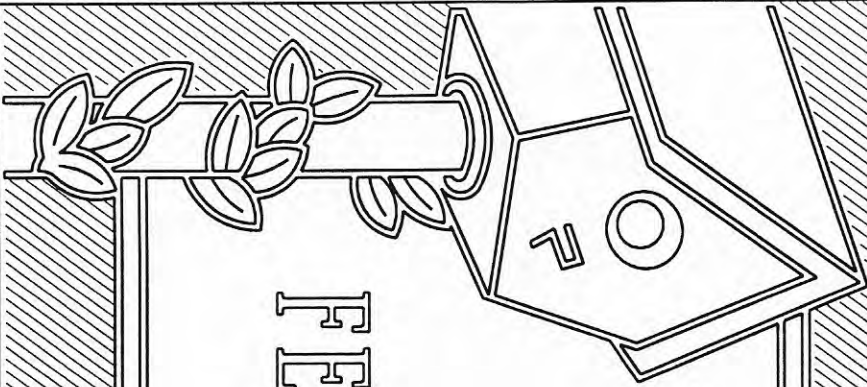

GO2M2412



ALWAYS IN OUR HEARTS



CARRON

NATHAN B.
1952 → 1995

SARAH V.
1953 →

GO3M3015

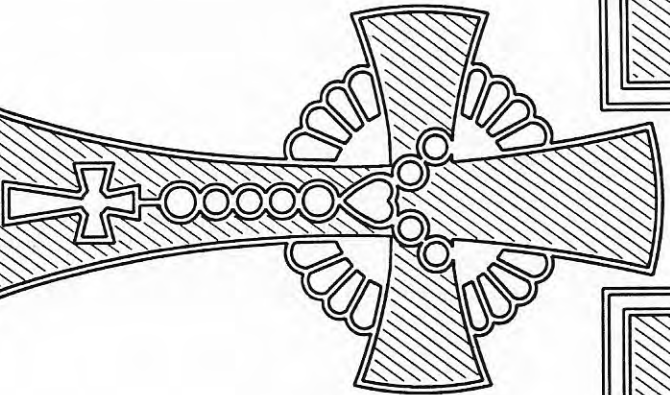

MATTHEW S.

GILGORAN

1933 — 1995

GO4M2412



WARDEN



ARTHUR S.
1922 → 1995

GOSM2412

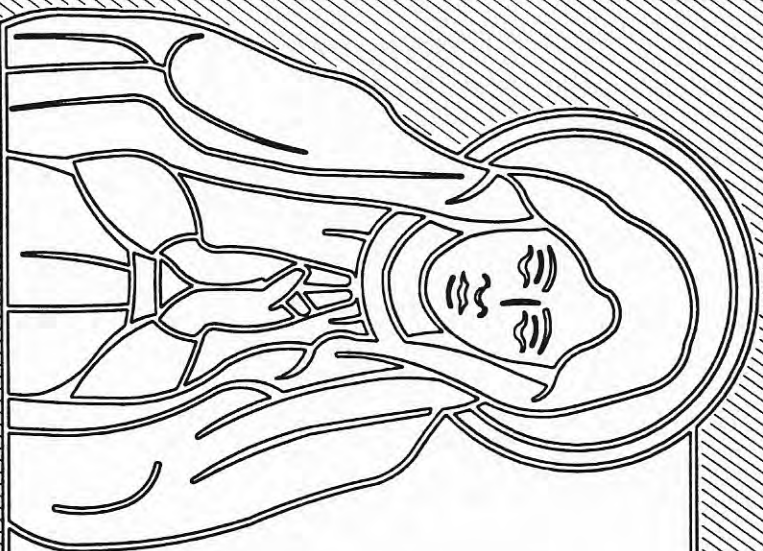

EMILLY M. DALL

MARCH 12, 1926

APRIL 4, 1995

G06M2412



REST IN PEACE

SOFIA S. PLANT

MAR. 12, 1936-JUNE 2, 1995

GO7M2412

STANLEY J. SIKES

1935

1994



G08M2412

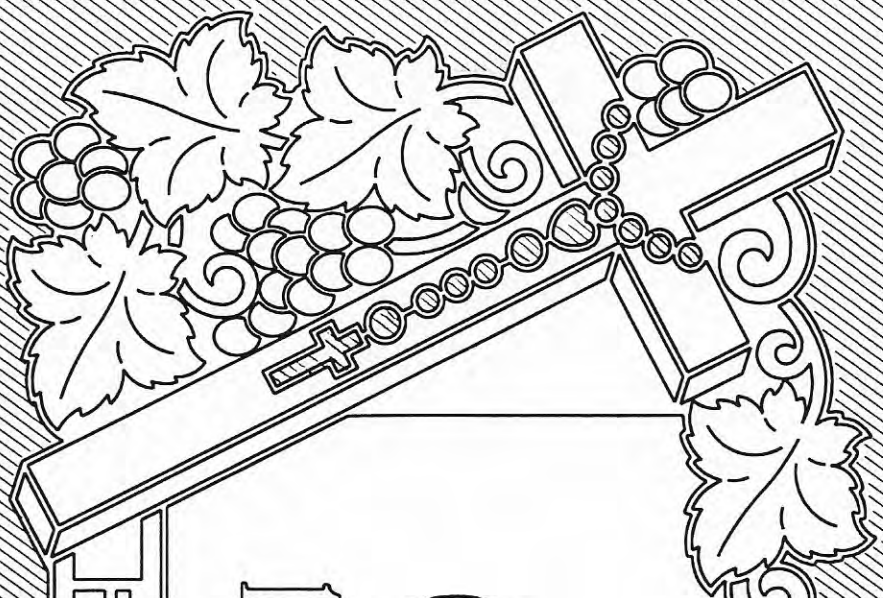

IVAN W.

CORNERTON

1917 — 1987

FOR EVER IN OUR HEARTS

G09M2412



OUR BABY

LUTHER JAMES MASK

SEPT. 12, 1995

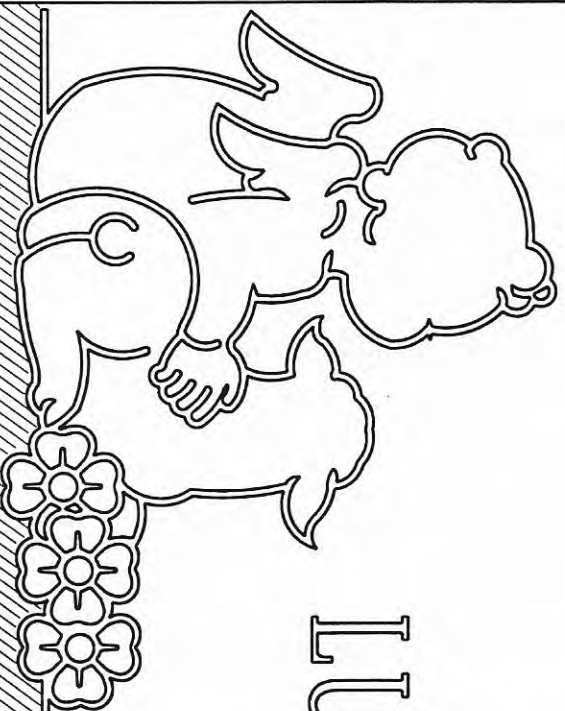

G10M2412

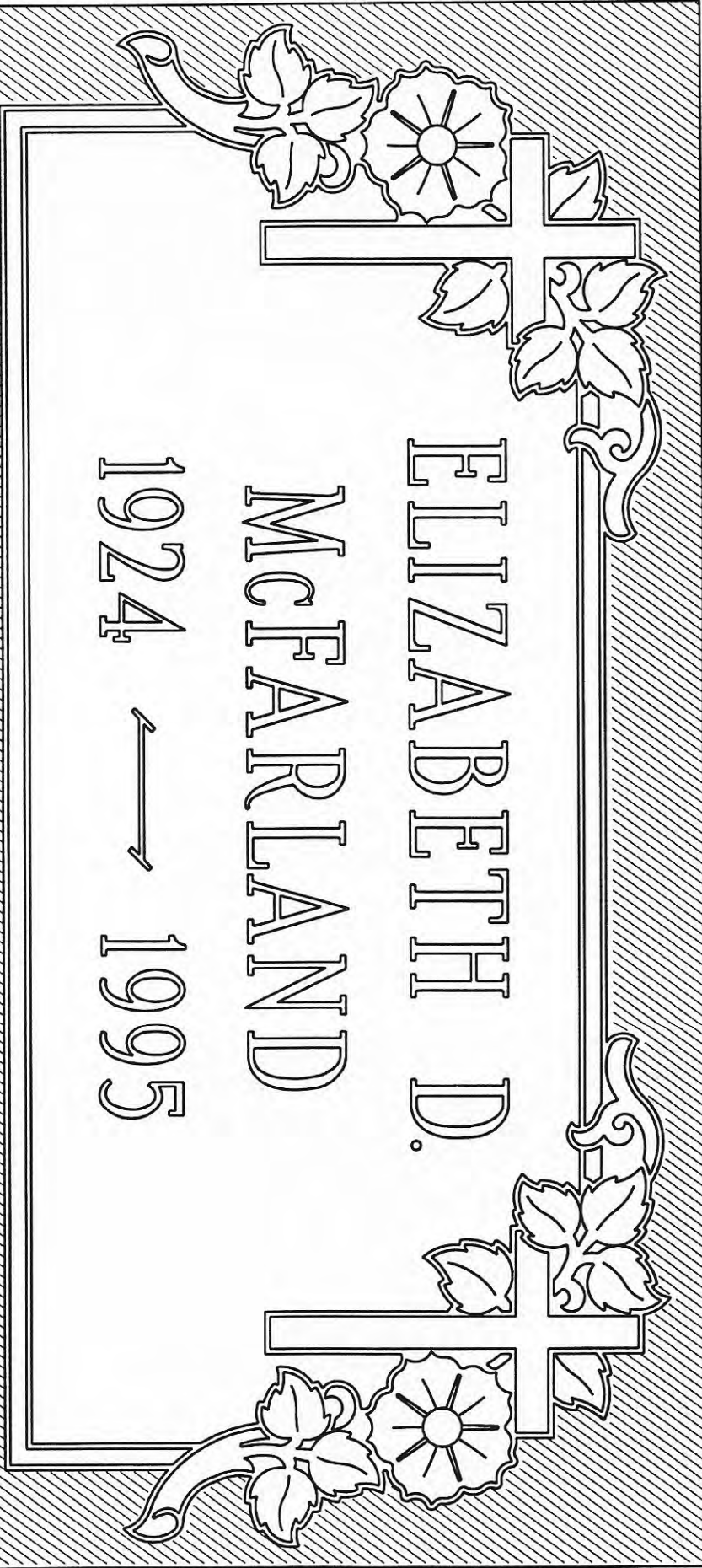
A decorative border with a central cross. The cross is formed by two vertical bars and two horizontal bars. The top and bottom horizontal bars are adorned with floral motifs, including a large sunburst flower and several leaves. The left and right vertical bars are also decorated with leaves and a scroll-like flourish at the top and bottom. The entire border is set against a background of diagonal hatching.

ELIZABETH D.
MCFARLAND
1924 — 1995

G11M2412

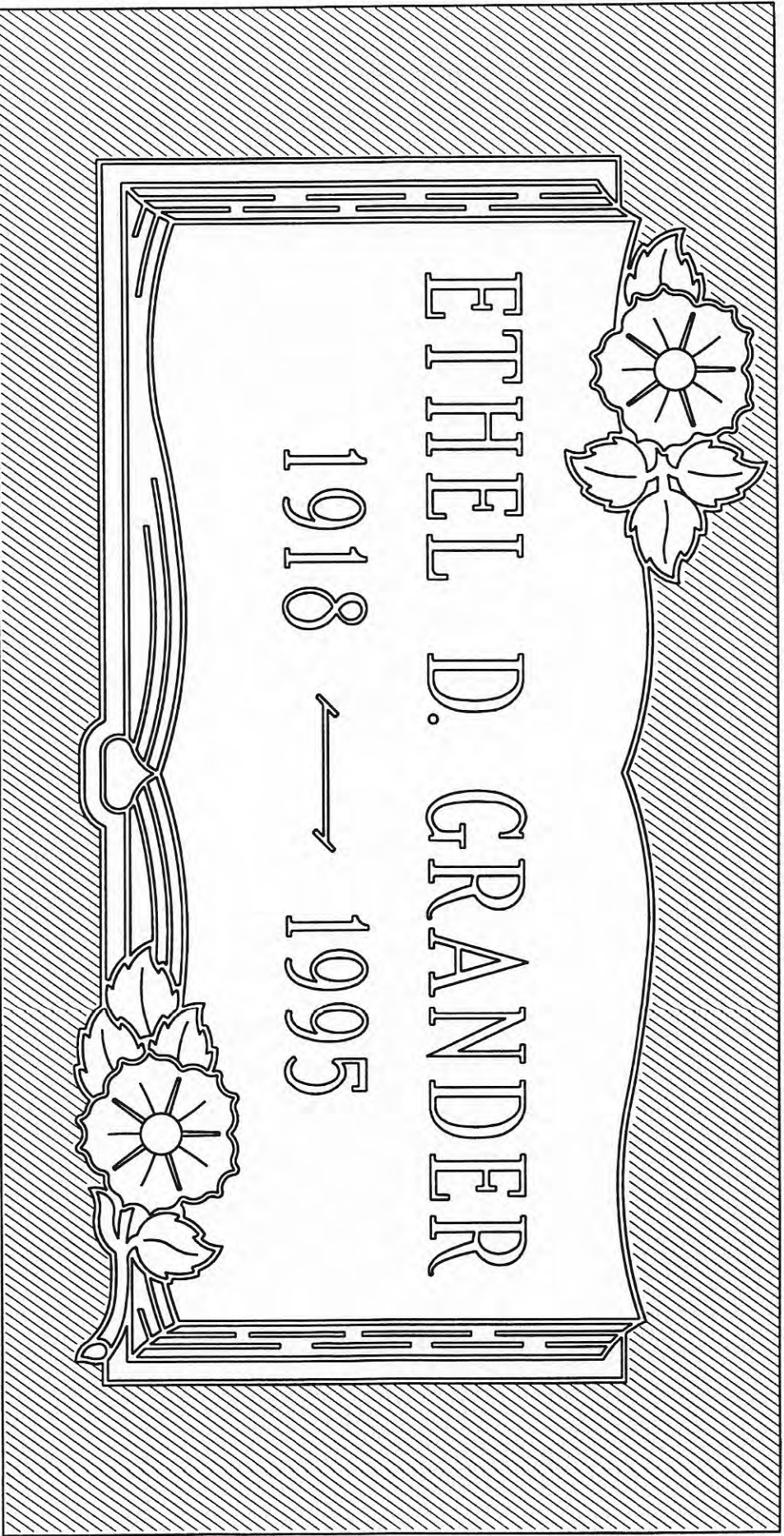

ETHEL D. GRANDER

1918 → 1995

G12M2412

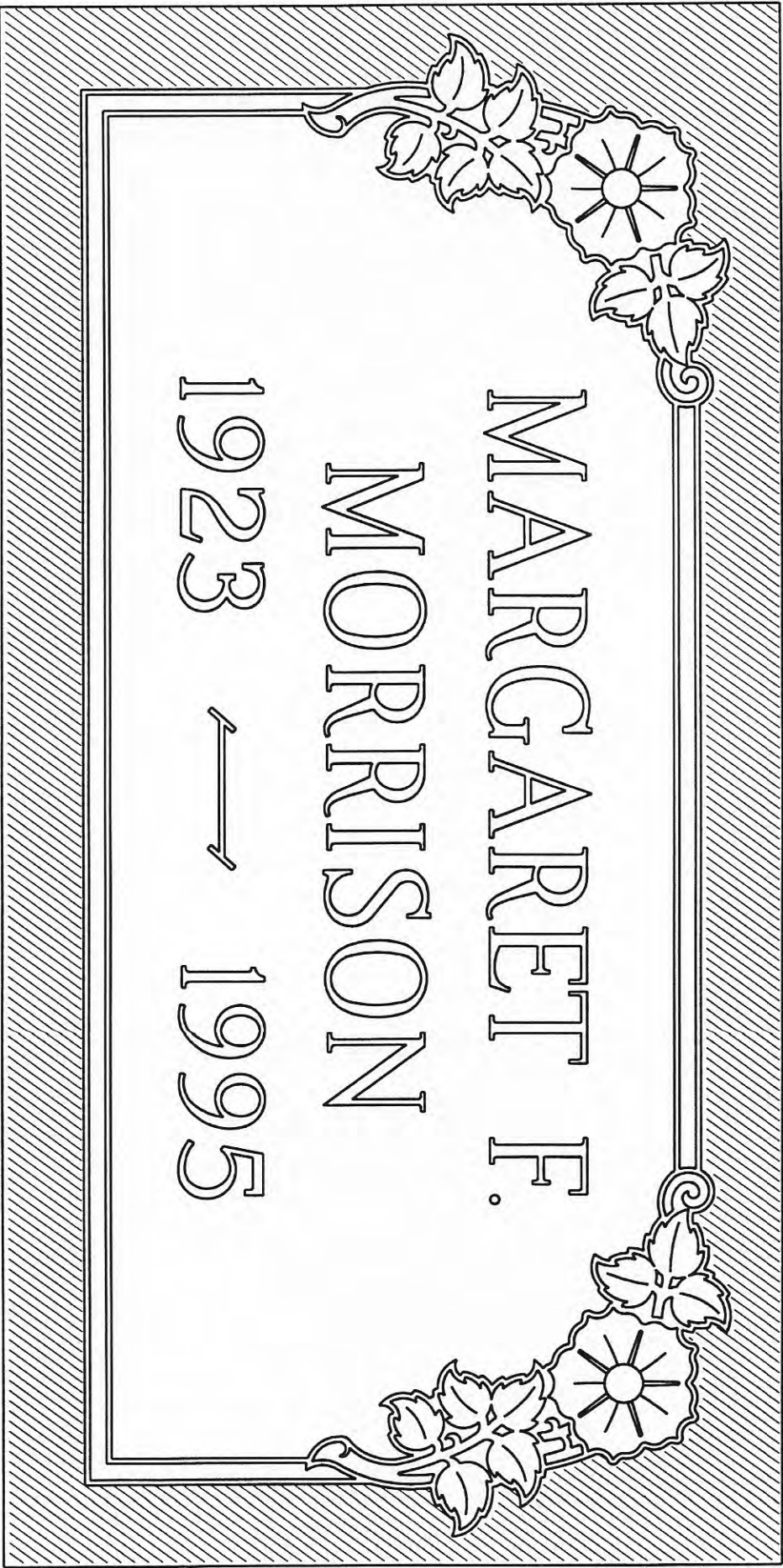

MARGARET F.
MORRISON
1923 — 1995

G13M2412

TOGETHER FOREVER

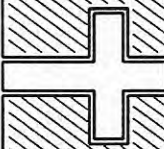

STEEFANIE W.

MATTINGLY

1943 — 1995

G14M2412

TERRY LITTLE

MARCH 21, 1992

JUNE 14, 1995

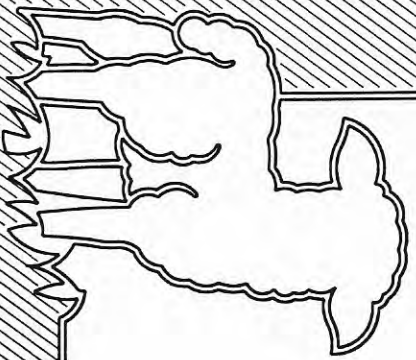

G15M2412

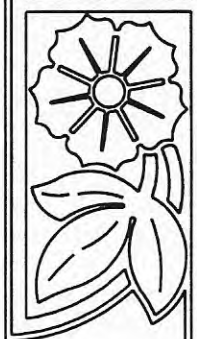

K I I N G

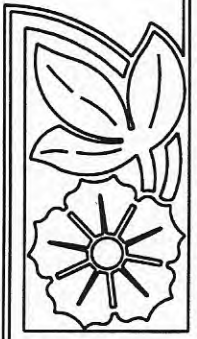

R O B E R T F. S U S S A N M.

1933 → 1995



G16M2412

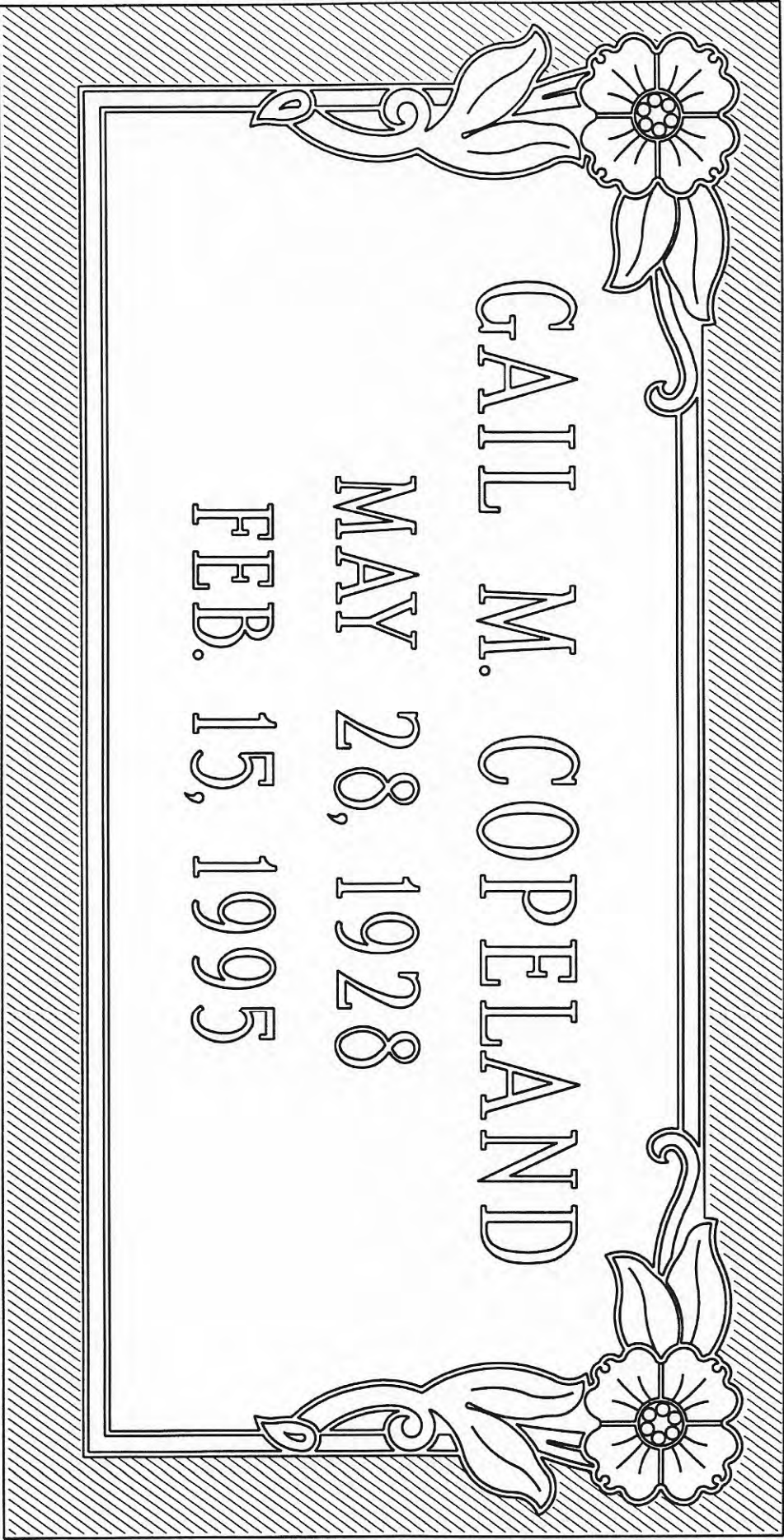

GAIL M. COPELAND
MAY 28, 1928
FEB. 15, 1995

G17M2412

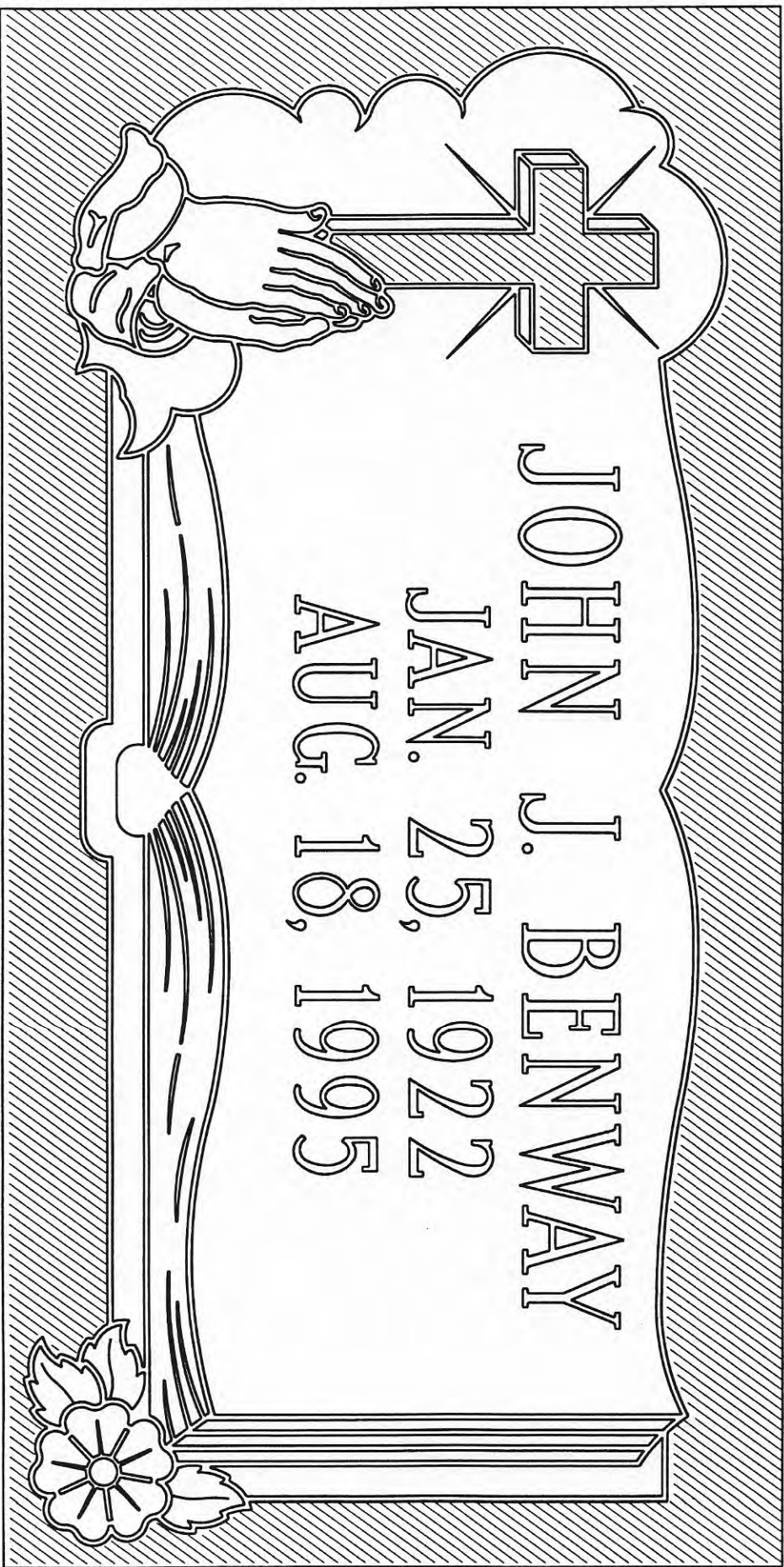

JOHN J. BENWAY

JAN. 25, 1922

AUG. 18, 1995

G18M2412

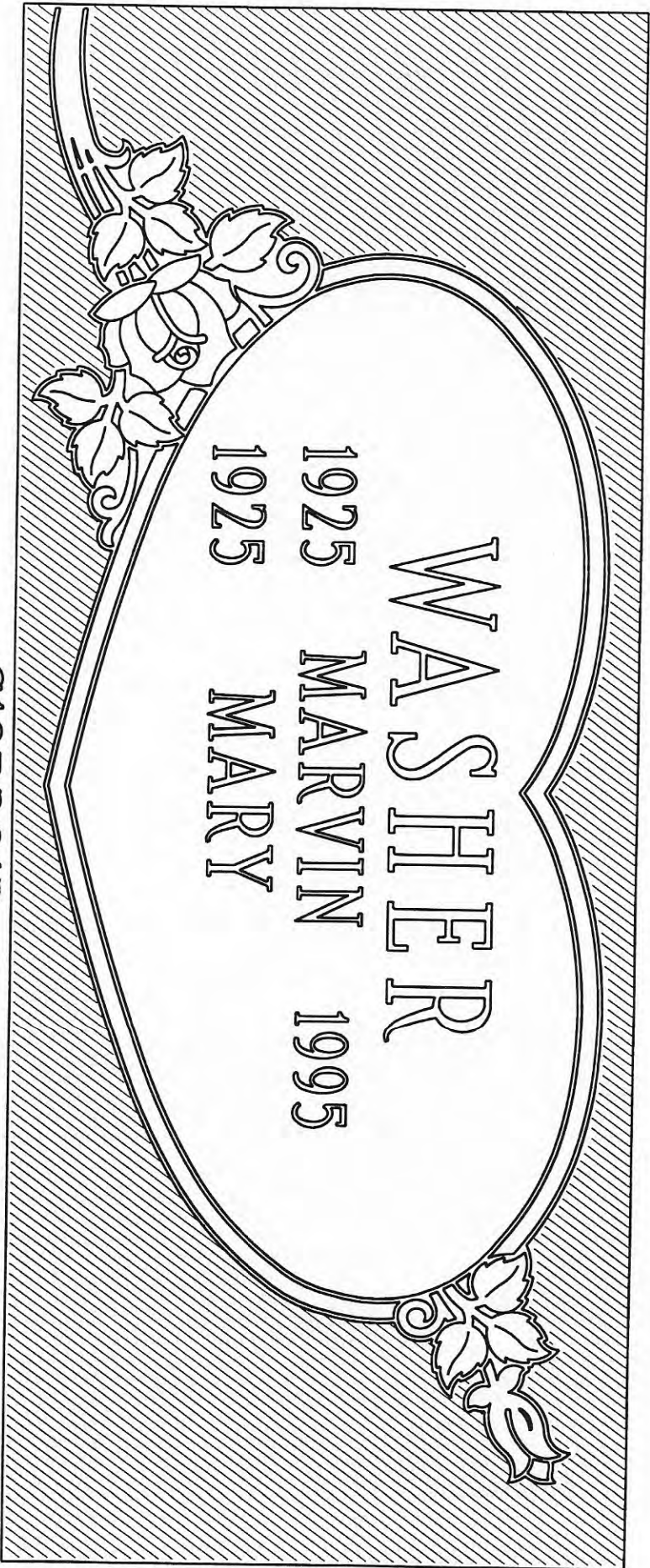

WASHEER

1925 MARVIN 1995

1925 MARY

G19D3012



JOANNNE

MAANNIGGER

NOV. 12, 1932

MAY 4, 1995

G20M1812



OUR LITTLE ANGEL
ROBERT LEE
HOCKER
FEB. 12, 1995

G21M1608

ERIC K. STUNNER

1966 → 1994

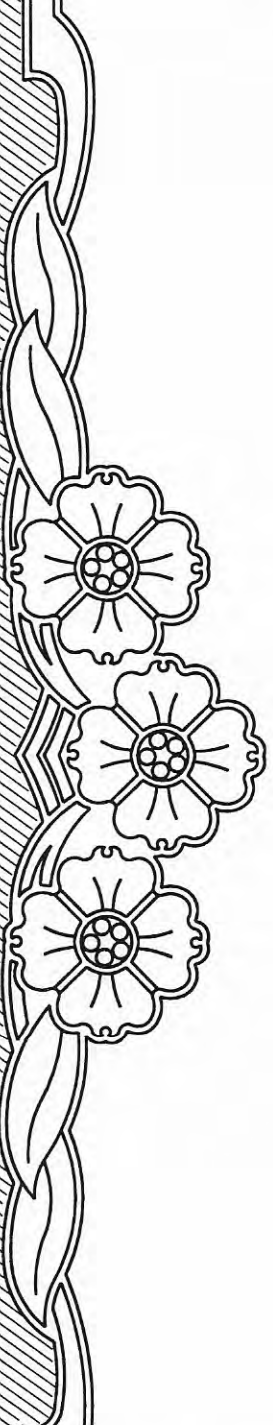

G22M2010

TELLER

ROBERT V.
1922 →

GLORIA N.
1925 → 1995

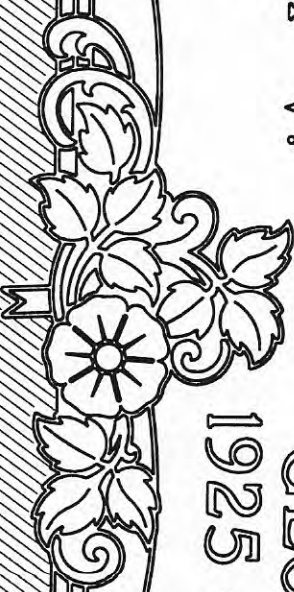

G23M3612

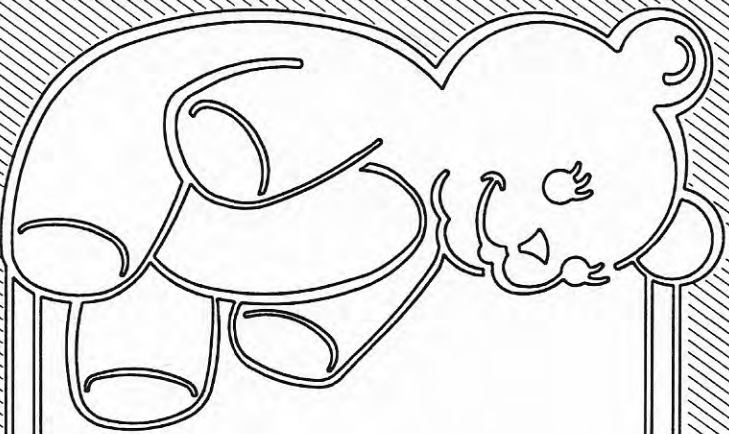

BELLOVED SON

KALOB BROWN

SEPT. 24, 1995

G24M2210

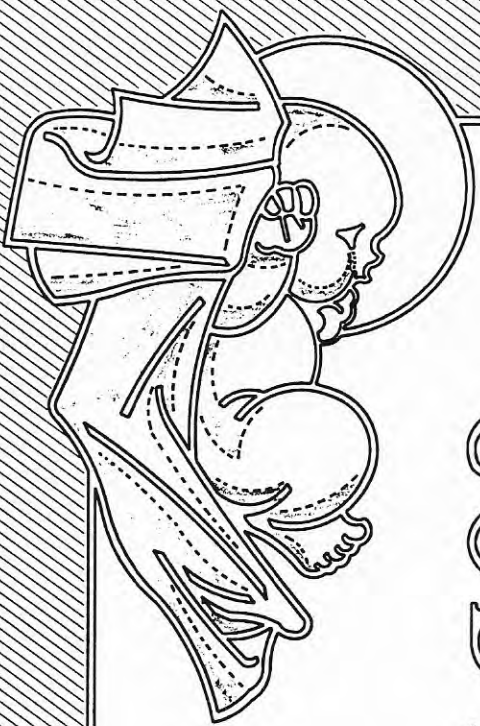

CODY GIFFORD

AUG. 15, 1995

OCT. 6, 1995

G25M2210

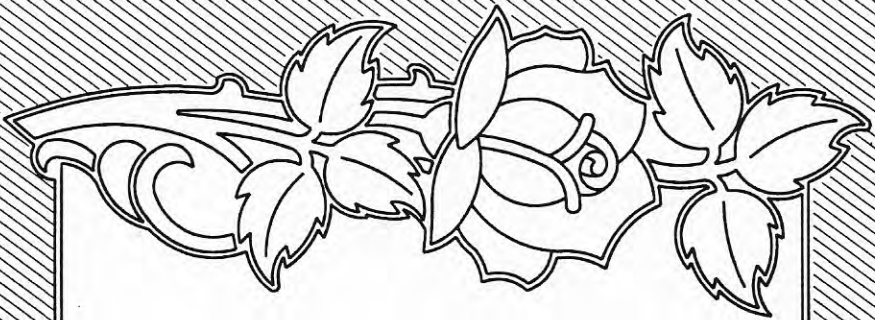

AGNES B.

RUMPLE

1922 — 1995

G26M2412

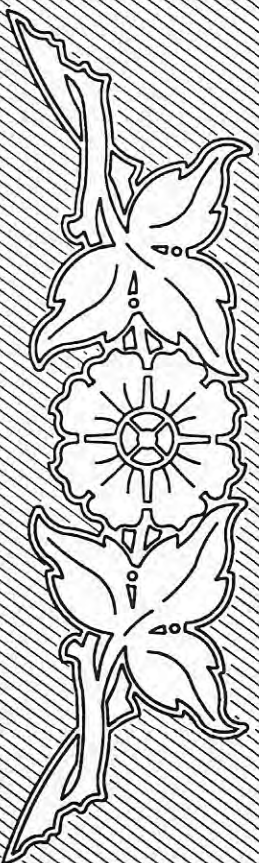

ANSON

LEROY C.
1929 — 1992

MOLLY R.
1930 — 1995

G27M2414

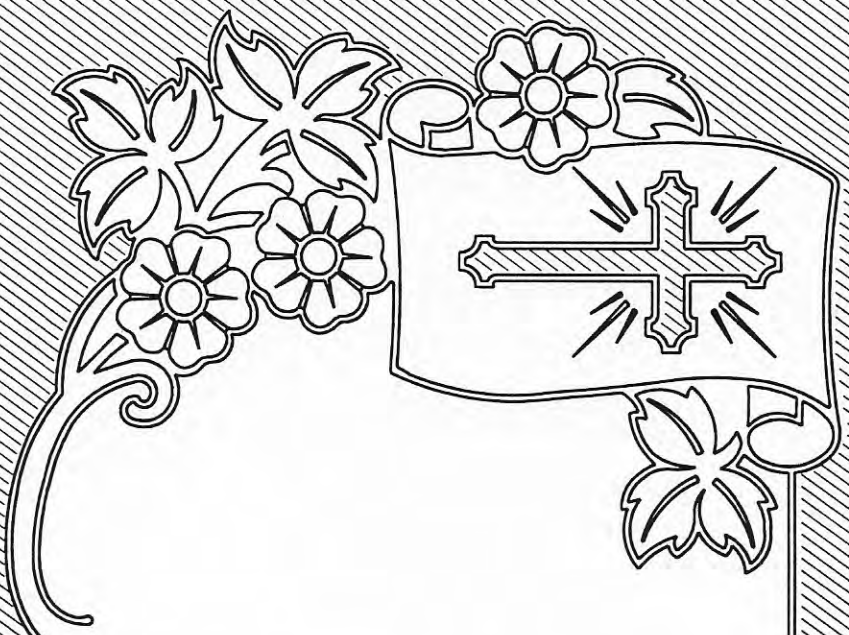

AMANDA S.

TELLERTON

1934 — 1995

G28M2412

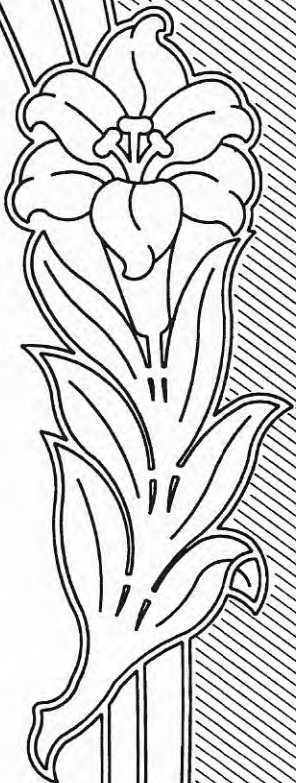

MARSHA B. AMBER

1945 → 1995

G29M2010

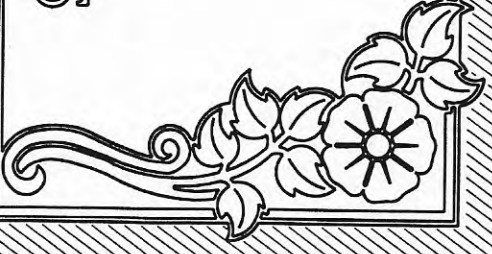
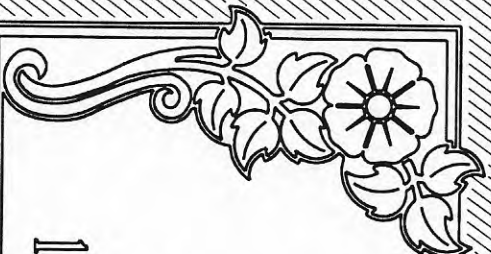

JOHNSON

WILLIAM S.

1917 → 1976

LOUISE P.

1922 → 1995

G30M3612

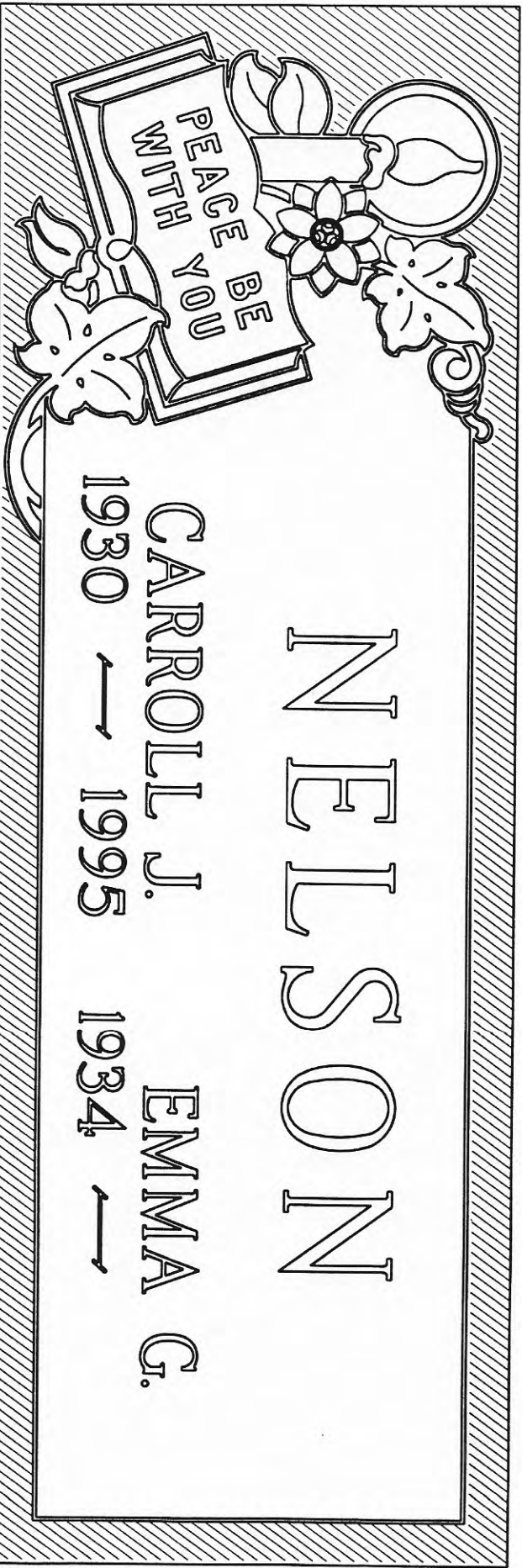

NELSON

CARROLL J. EMMA G.
1930 — 1995 1934 —

G31M3612

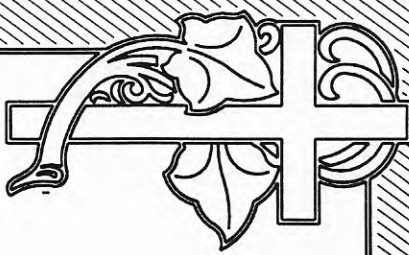

GARTNER

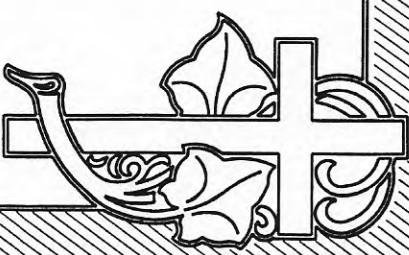

BRUCE W. JR.
1923 → 1987

LISA MARIE
1926 → 1995

G32M3612

MANDELL

CARL D.

1933 - 1995

CATHY F.

1932 -

G33M2412

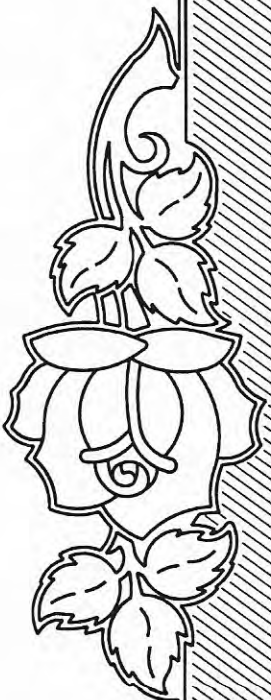

MADDELINE S. LAROSE

1925 — 1995

G34M2412

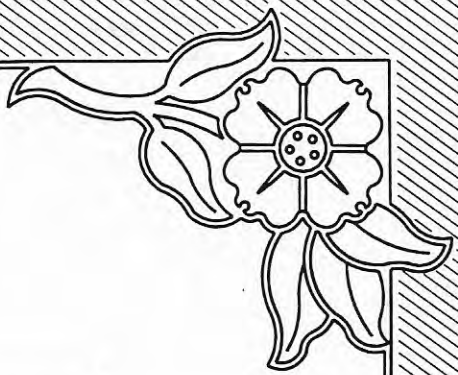

STEPHEN K.

PERREAULT

1935 — 1995

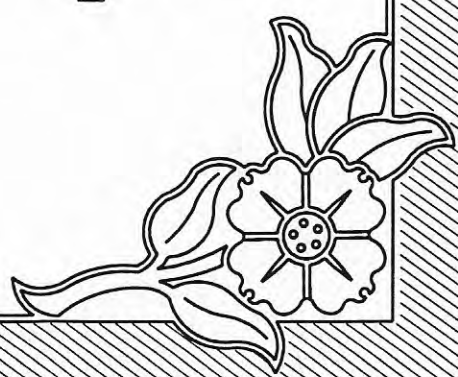

G35M2412

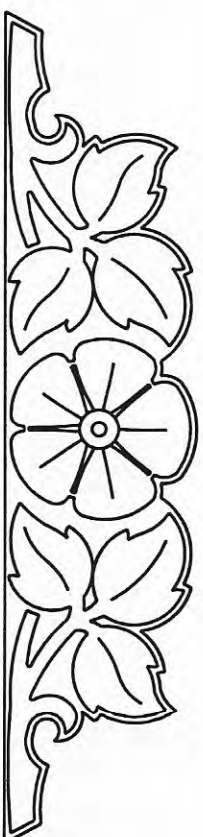

DIANA L. ROGERS

1906 — 1987

G36M2412

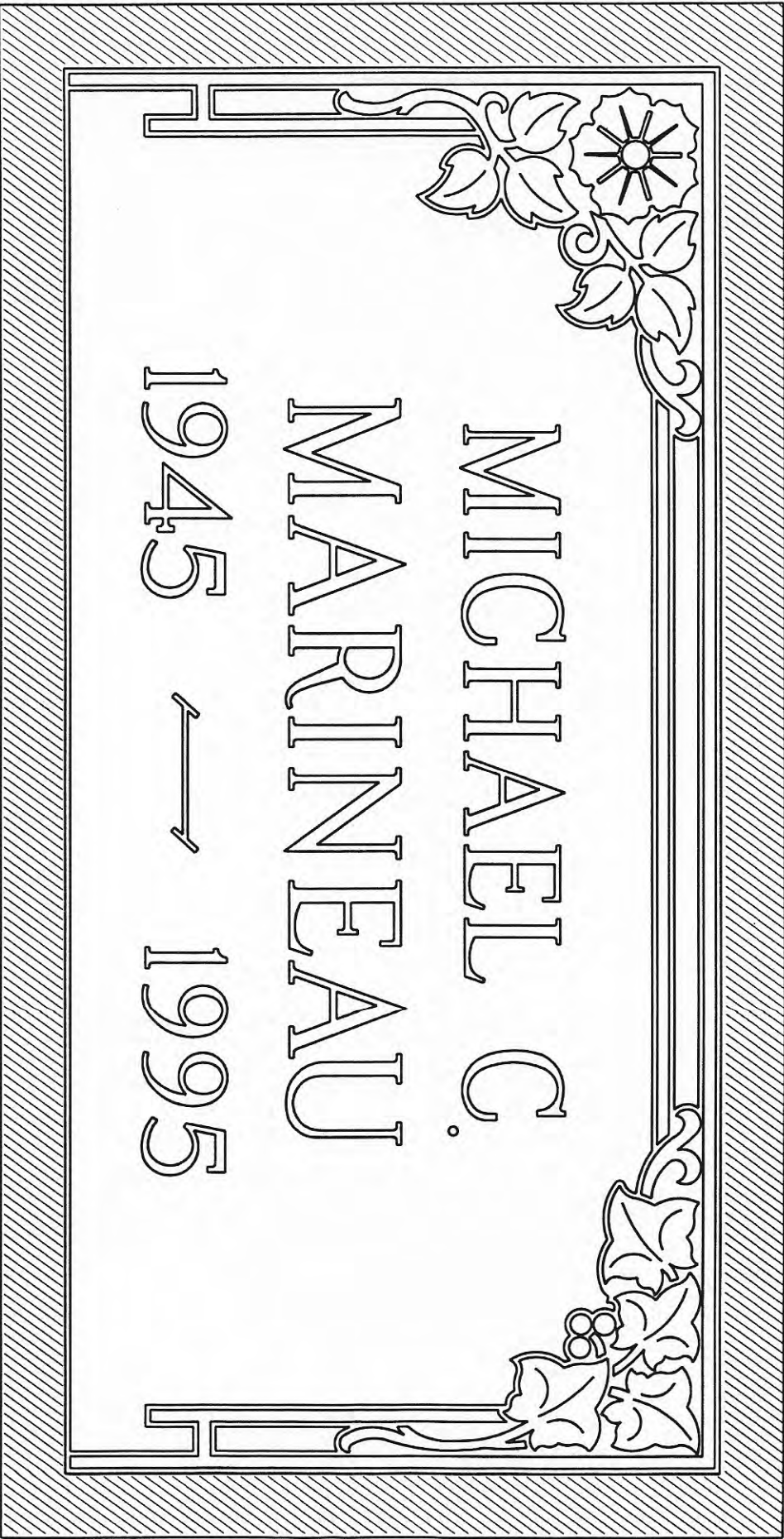

MICHAEL C.
MARRINEAU
1945 — 1995

G37M2412

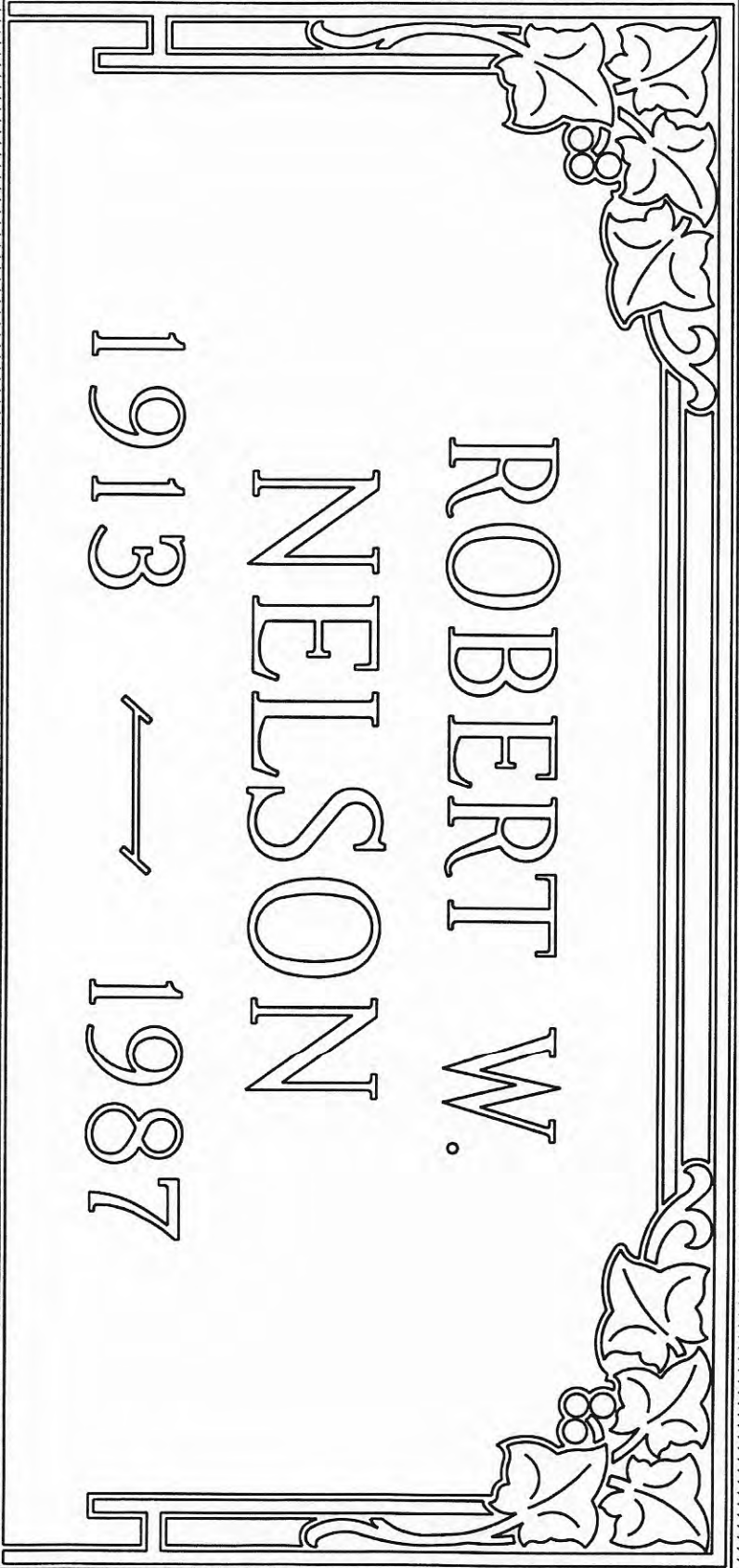

ROBERT W.
NELSON
1913 — 1987

G38M2412

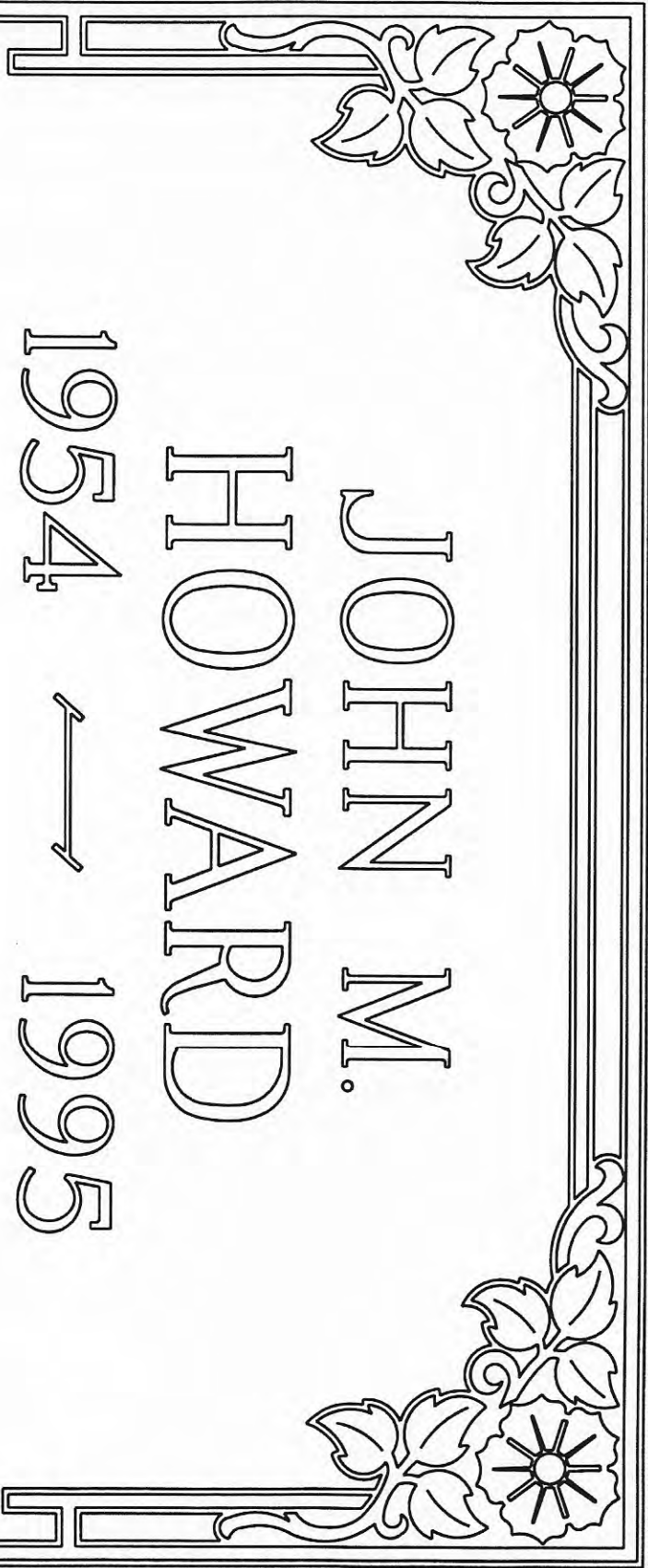

JOHN M.

HOWARD

1954 — 1995

G39M2412

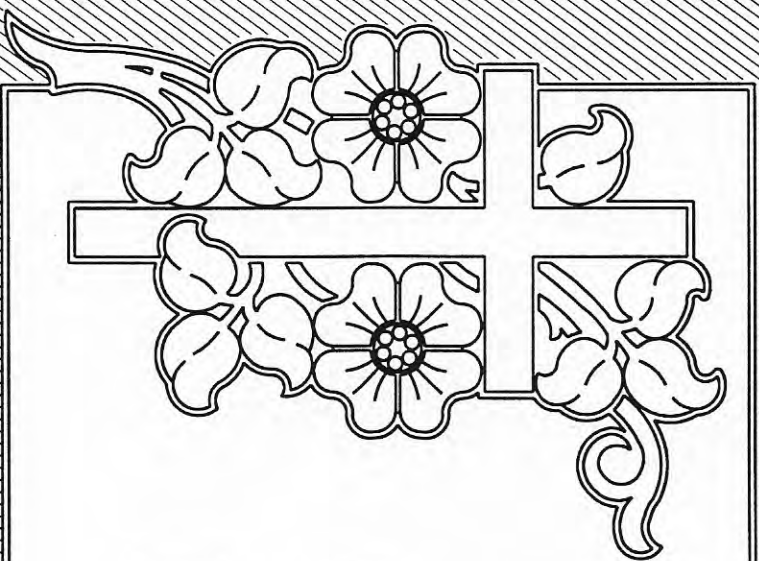

WAYNE K.

GRISSWALD

1962 → 1995

G4OM2412

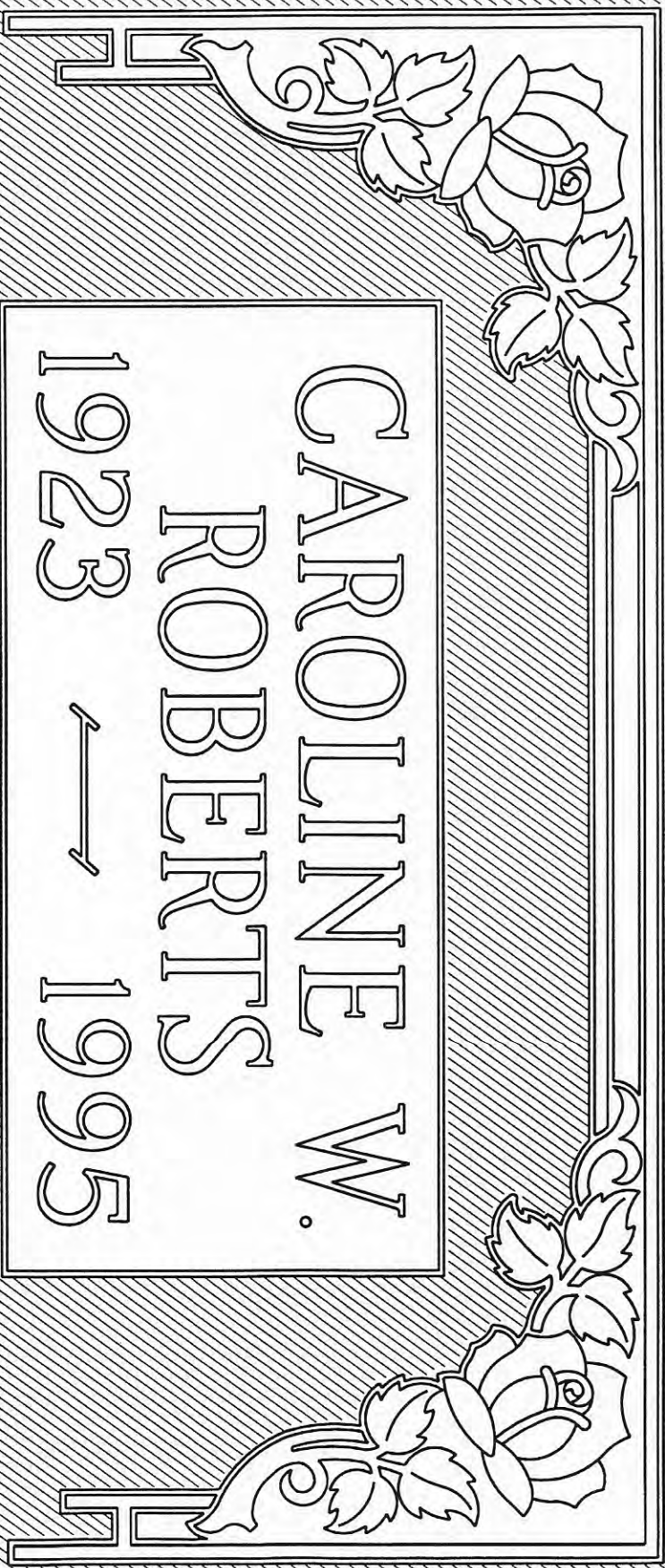

CAROLINE W.
ROBERTS
1923 — 1995

G41M2412

TANNER

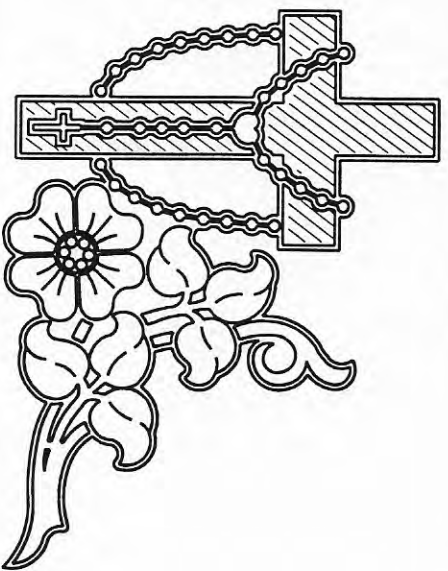

CARL M. 1952 → 1992
SARA G. 1953 → 1995

G42M3012



MARTHA H.
HALLSBERG
1923 — 1995

G43M2412

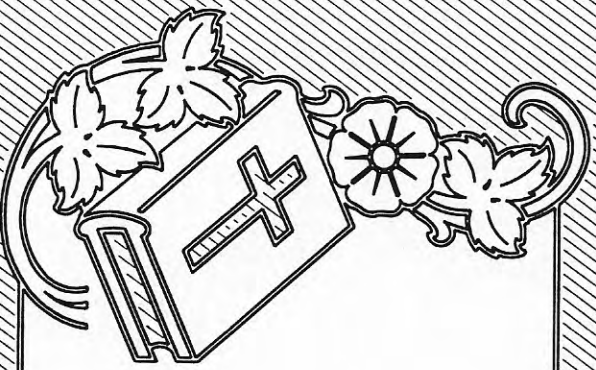

WENTWORTH

ABRAHAM D.

LINETTE S.

SEPT. 12, 1923

FEB. 24, 1924

NOV. 23, 1995

G44M3612

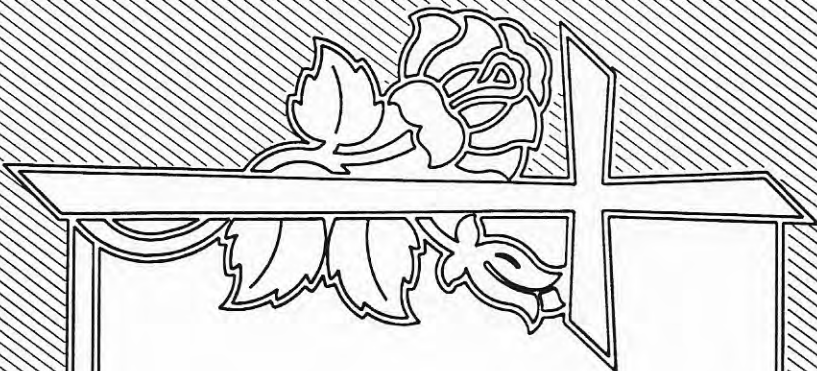

MILTON JOHN
MECLLENBERG
1922 — 1995

G45M2412

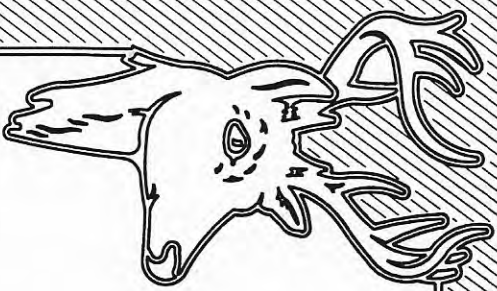

MARKER

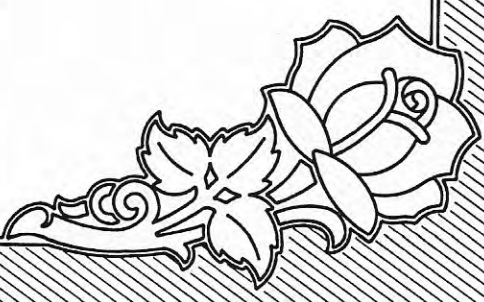

BUCK K.

ROSE M.

1910 →

1995

1912 →

1992

G46M2412

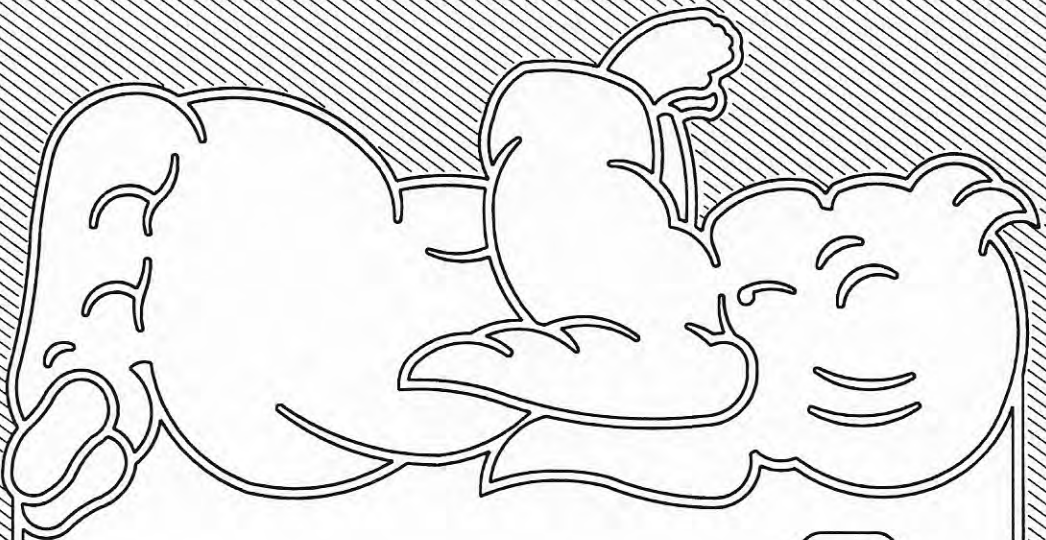

OUR LITTLE ANGEL

SIMON RAY

DONOVAN

1992 - 1995

G47M1410

GEORGE D. MILLS

1910 → 1995



G48M2412

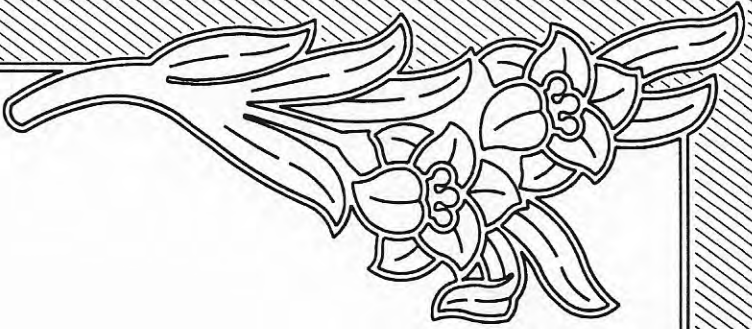

MARTIN V. SAILS

1924 → 1995

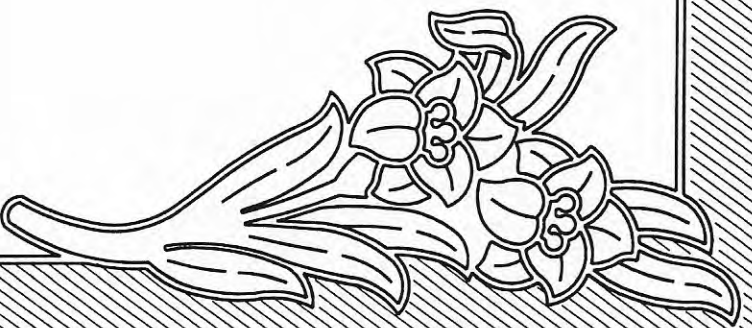

G49M2010

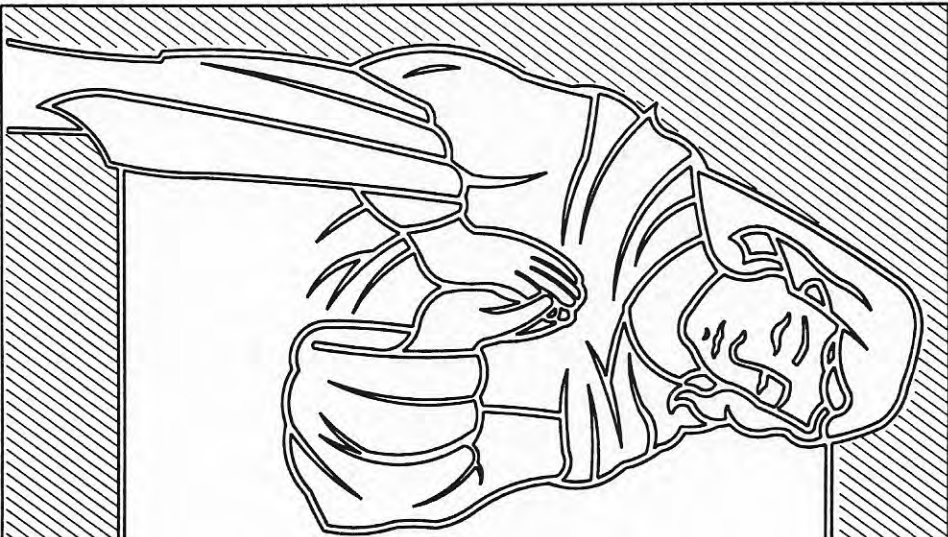

VICTORIA D.

FRANKLIN

1912 — 1995

G50M2412

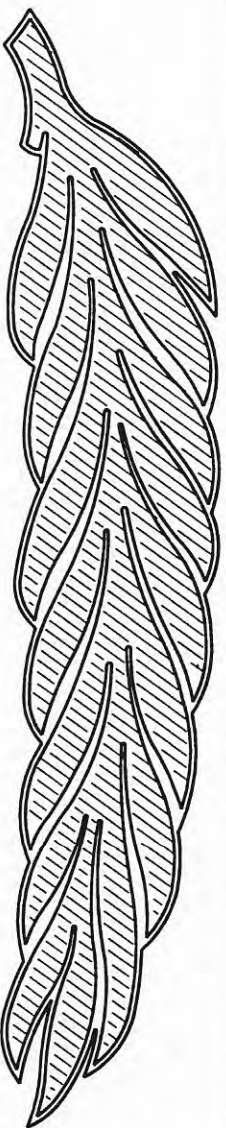

ALAN V. MANCHESTER
APR. 12, 1932 - NOV. 23, 1995

GS1M2412

GARTNER

WENDELL S.
1909 → 1992

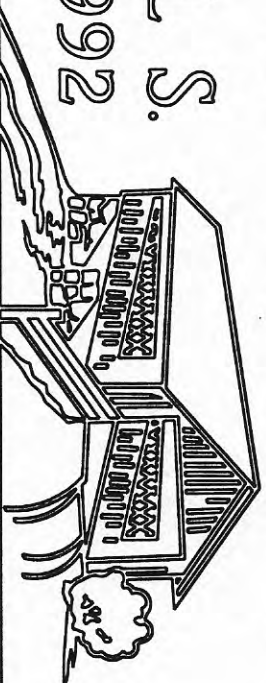

CAROL D.
1912 → 1995

G52M3612

MARTIN B. FLOWERS
SEPT. 2, 1932 - JULY 12, 1995

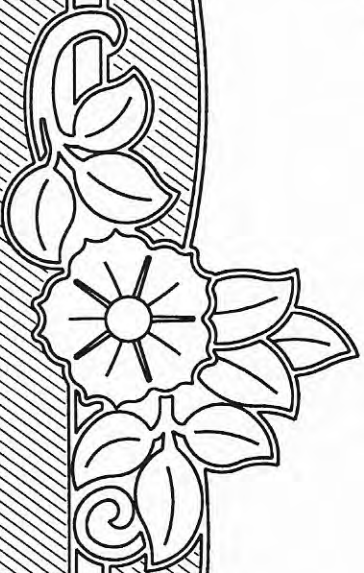

G53M2412

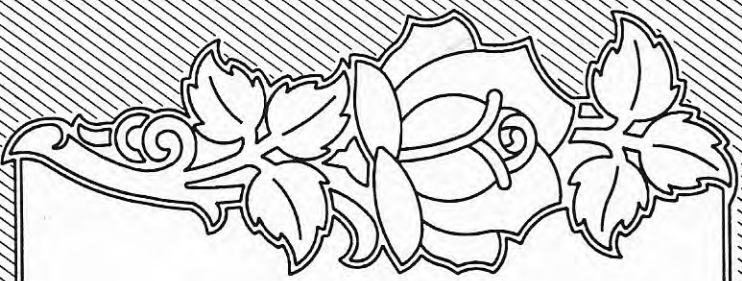

AMANDA H.

GANDERMAN

1923 — 1995

G54M2412

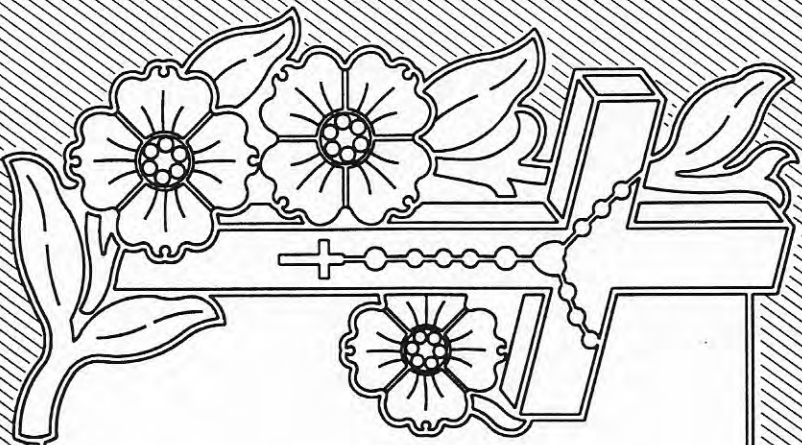

BENJAMIN D.
CARMATON
1915 — 1995

G55M2412



OUR BELOVED SON

MATTHEW S. CRIMSON

JUNE 2, 1992

MAY 23, 1995

G56M2412



MARTIN F. LANDDOWS

SEPTEMBER 12, 1933

OCTOBER 23, 1995

G57M2412

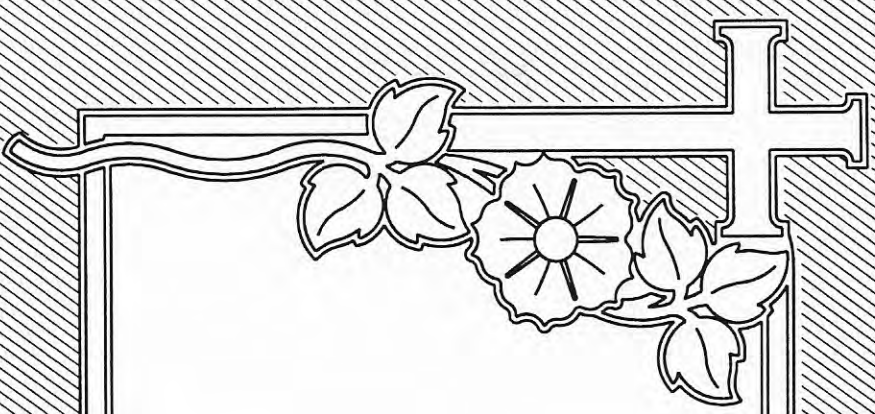

BENJAMIN D.

GREENSHAW

1943 ← 1995

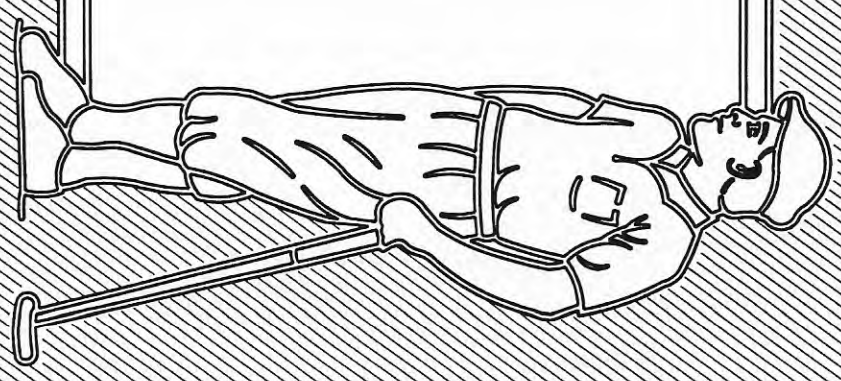

G58M2412



HENRY D SIKES

1924 → 1995

G60M2412

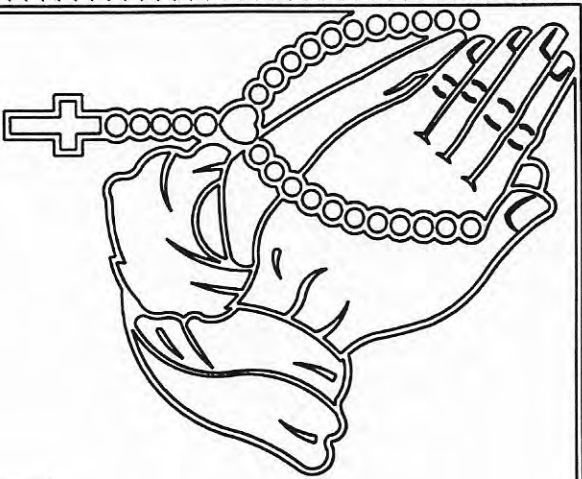

AMANDA W.

TOLLERSON

1932 — 1995

G61M2412

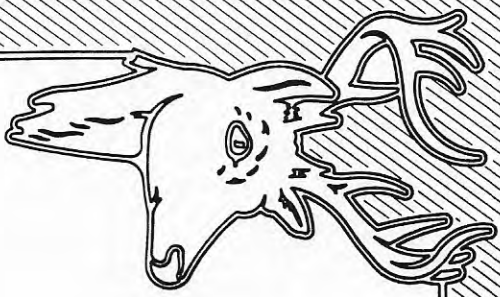

JACKSON

SPORTSMAN

1916 — 1995



G62M2412



MARILYN D. GELLER

1934 ↔ 1995

G63M2412

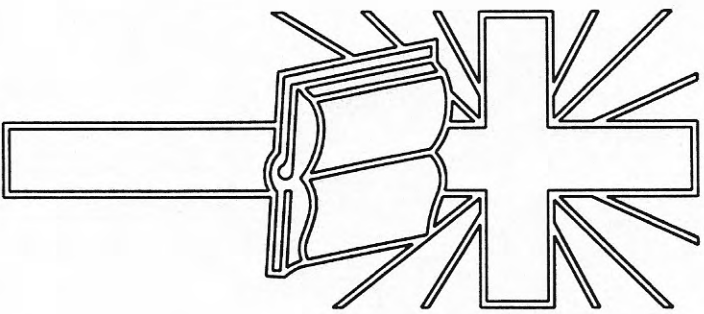

BELLOVED WIFE
AND MOTHER

MARTHA S. PARKS

SEPTEMBER 2, 1953

OCTOBER 4, 1995

G64M2412

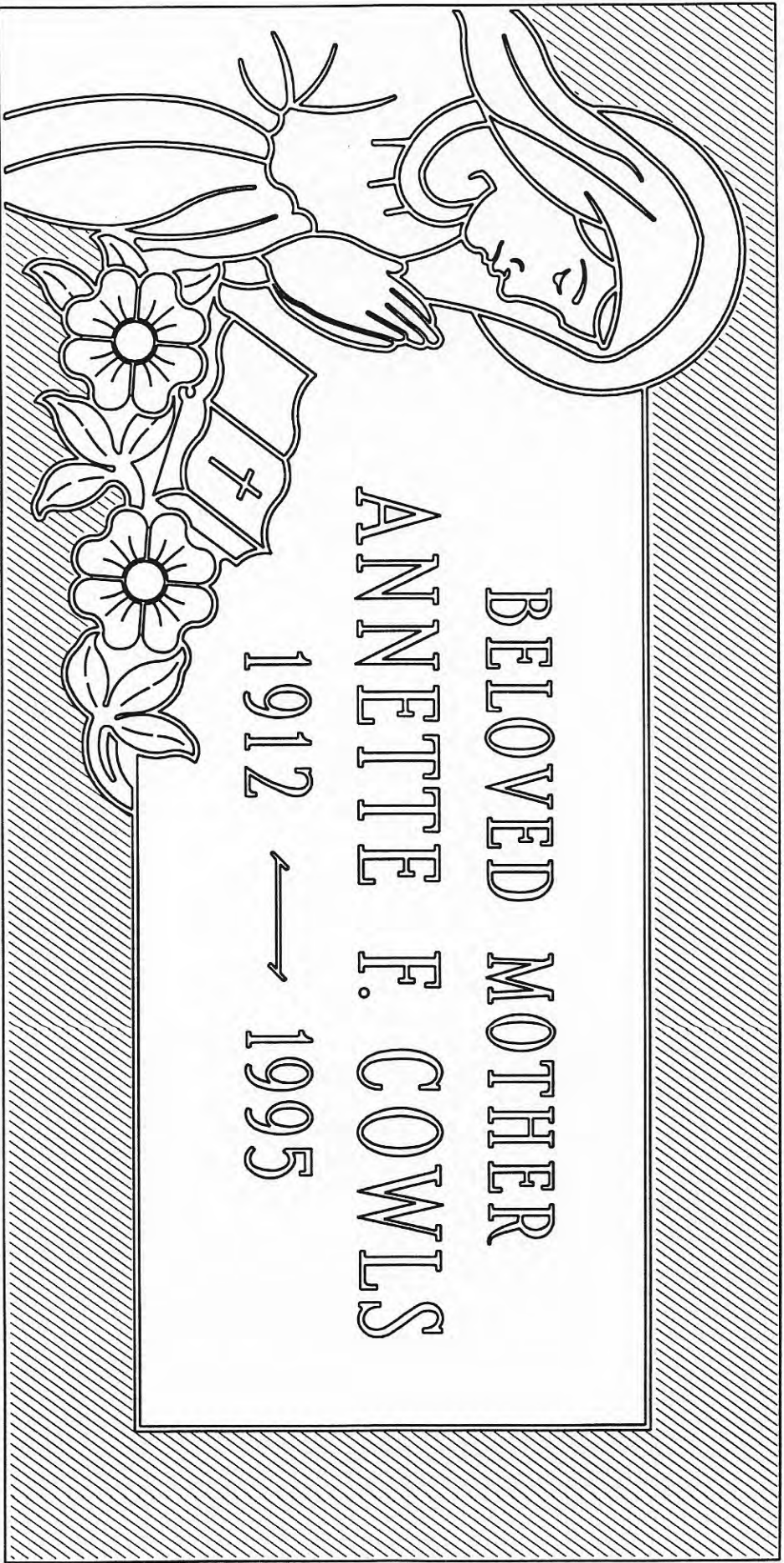

BELOVED MOTHER

ANNETTIE F. COWLS

1912 —→ 1995

G65M2412

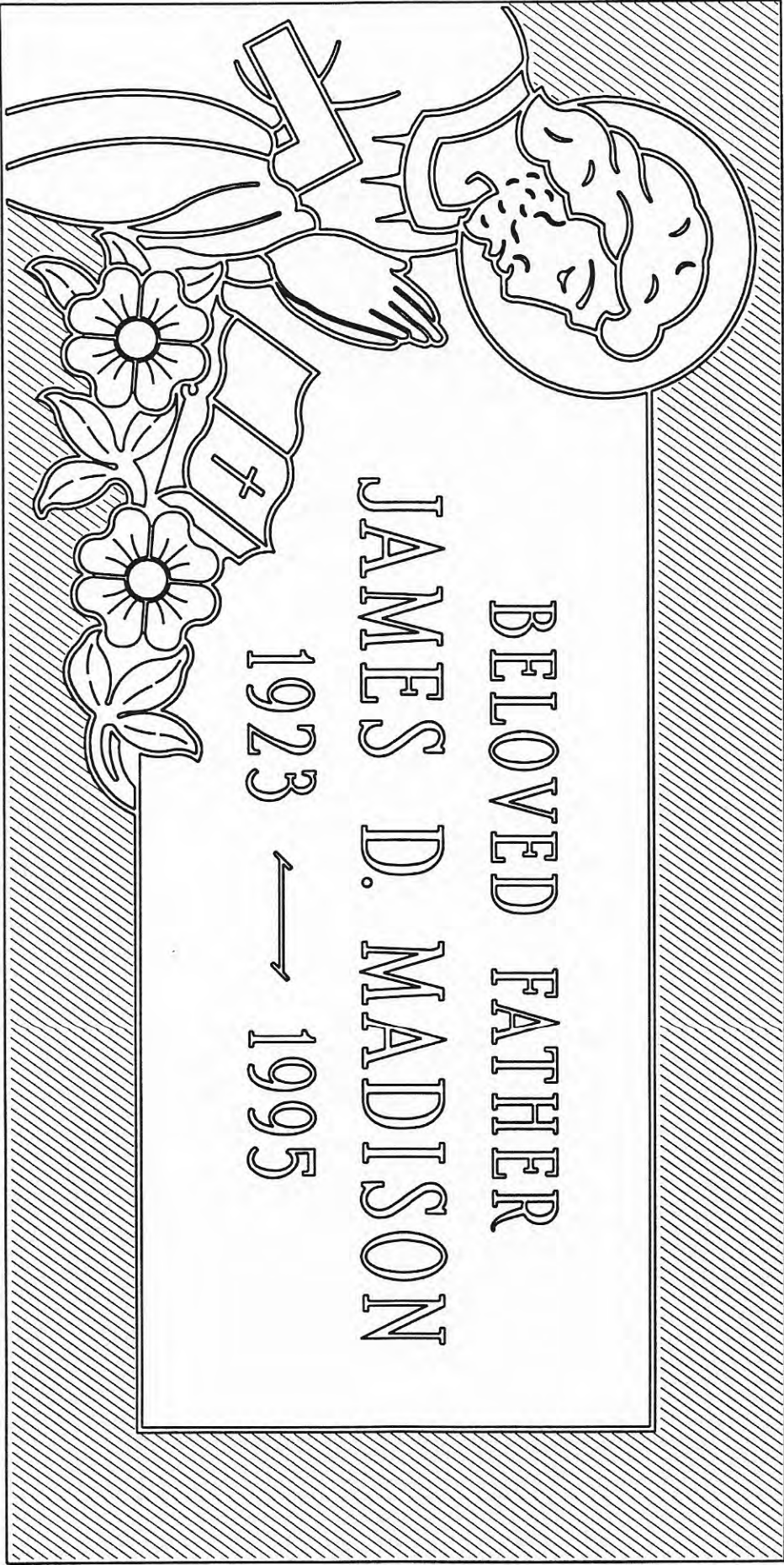

BELOVED FATHER

JAMES D. MADISON

1923 ↔ 1995

G666M2412

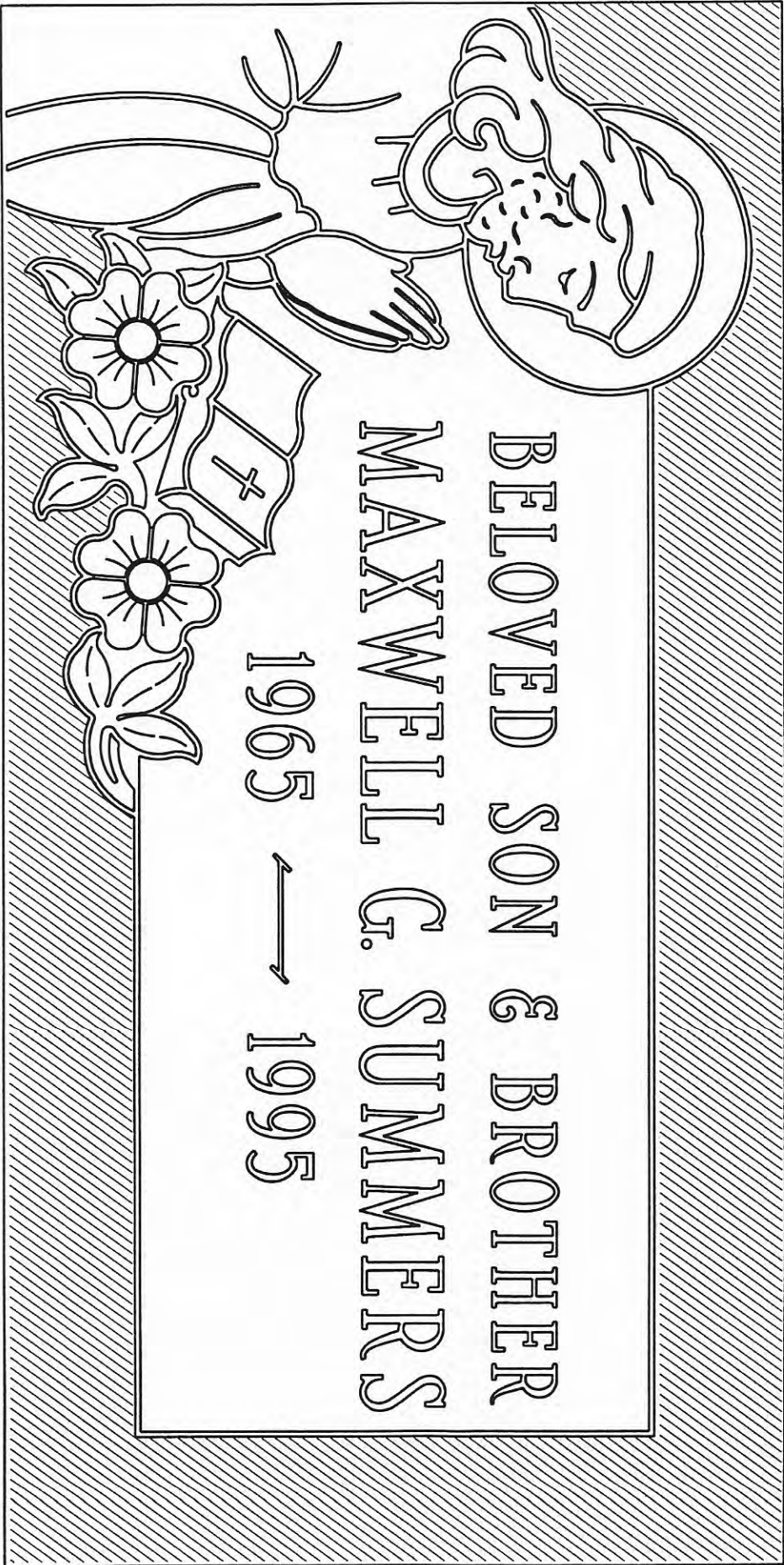

BELOVED SON & BROTHER

MAXWELL G. SUMMERS

1965 ↔ 1995

G67M2412

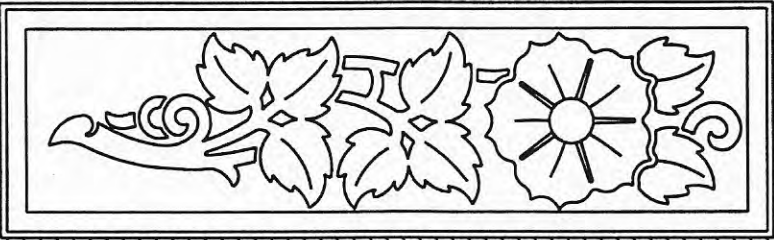

BELOVED WIFE
AND MOTHER
MAY G. SELLERS
SEPT. 3, 1946
MAY 23, 1995

G68M2412



JENNIFER S. WALKS

1932 — 1995

G69M2412

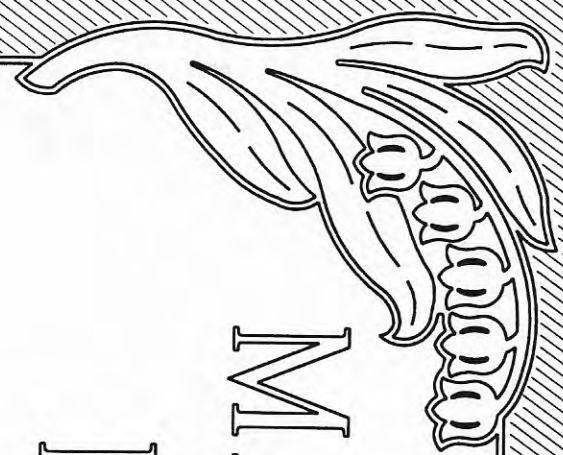

MABALLENNE S.

MORRISSEAU

1924 — 1995



G70M2412

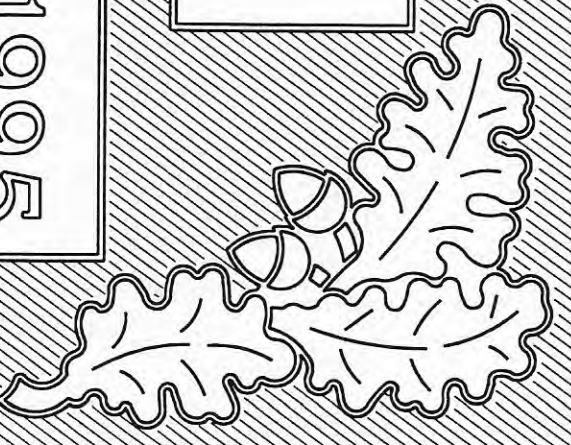
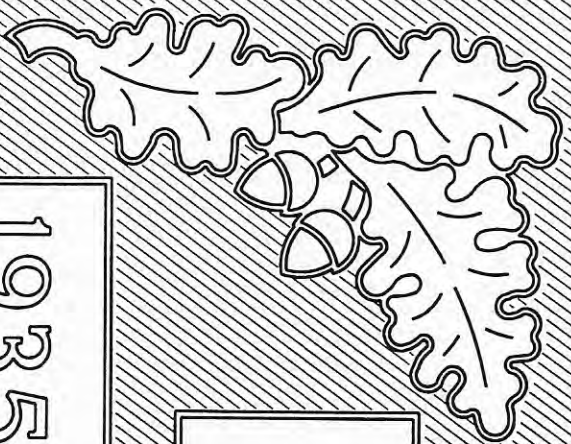

KELLER

1935 JOSEPH N. 1995
1938 JANET F.

G71M2412

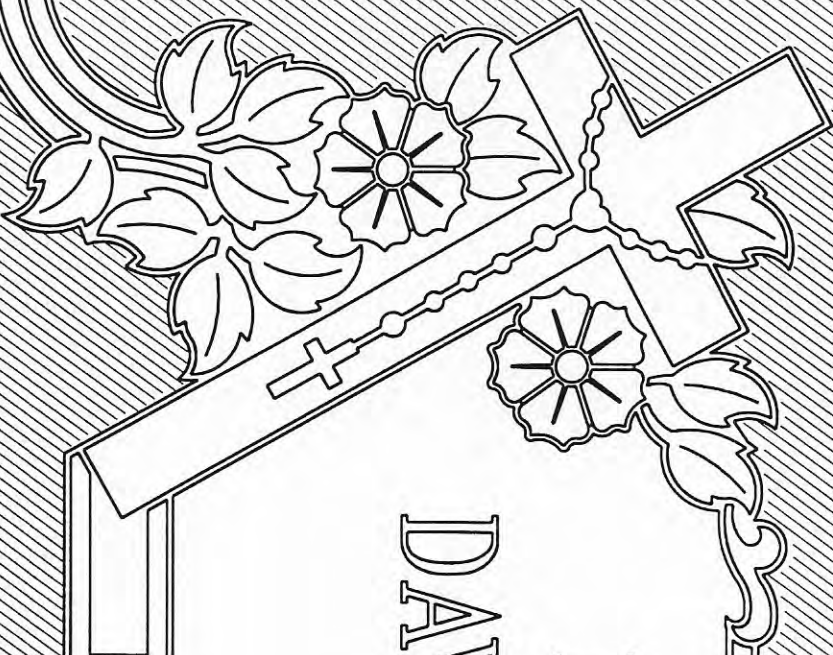

BELLOVED HUSBAND

DAVID G. CARPENTER

1923 ← 1995

FOREVER IN OUR HEARTS

G72M2412

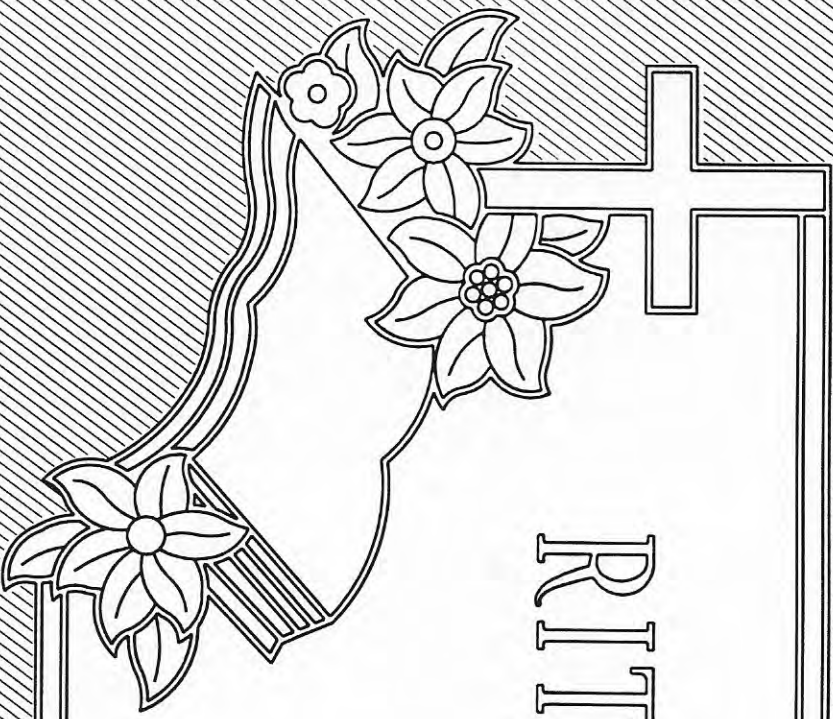

RITA F. CONTOIS

MAY 23, 1953

JUNE 2, 1995

G73M2412

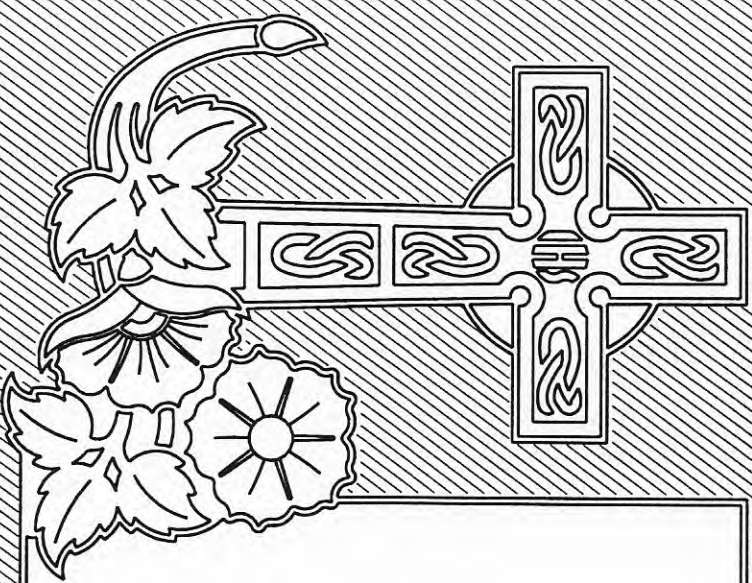

ARTHUR F.
ANDERSON
1932 — 1995

G74M2412

BELOVED MOTHER

SOPHIA G. LANDERMAN

DECEMBER 12, 1924

JANUARY 4, 1995

G75M2412

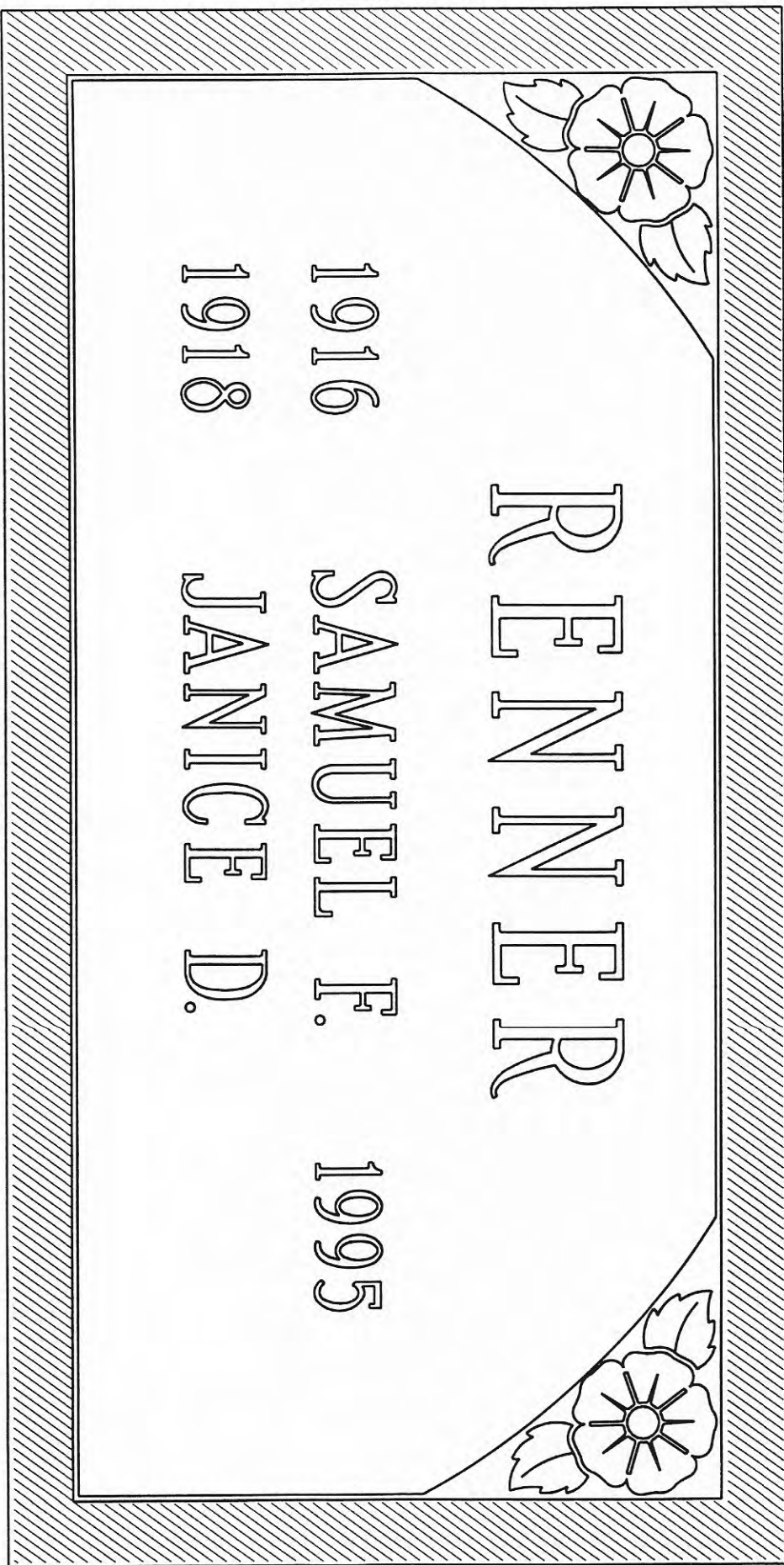

RENNER

1916 SAMUEL F. 1995

1918 JANICE D.

G76M2412

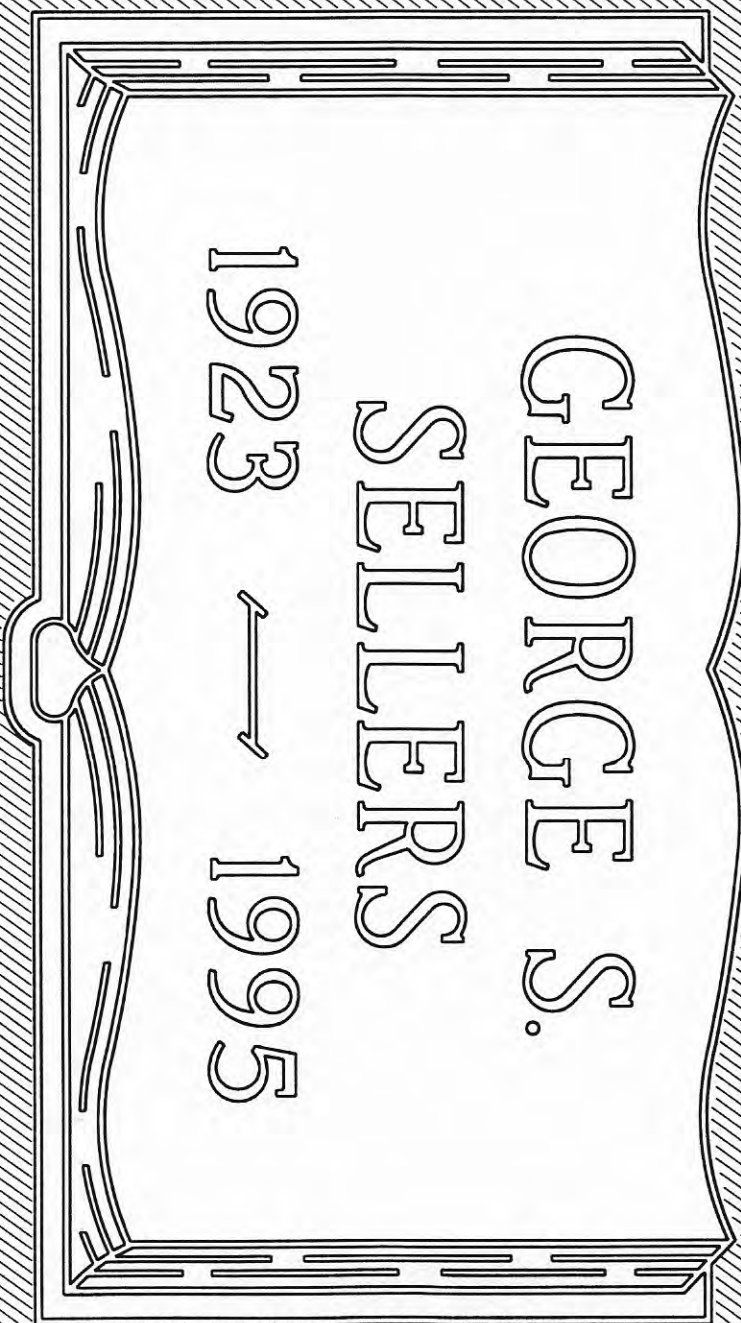
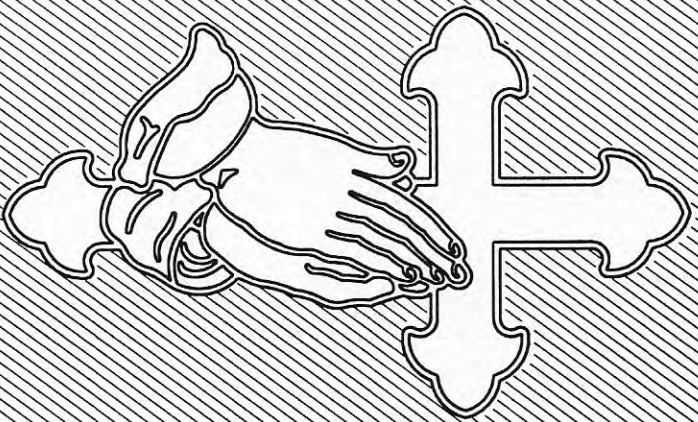

G77M2210

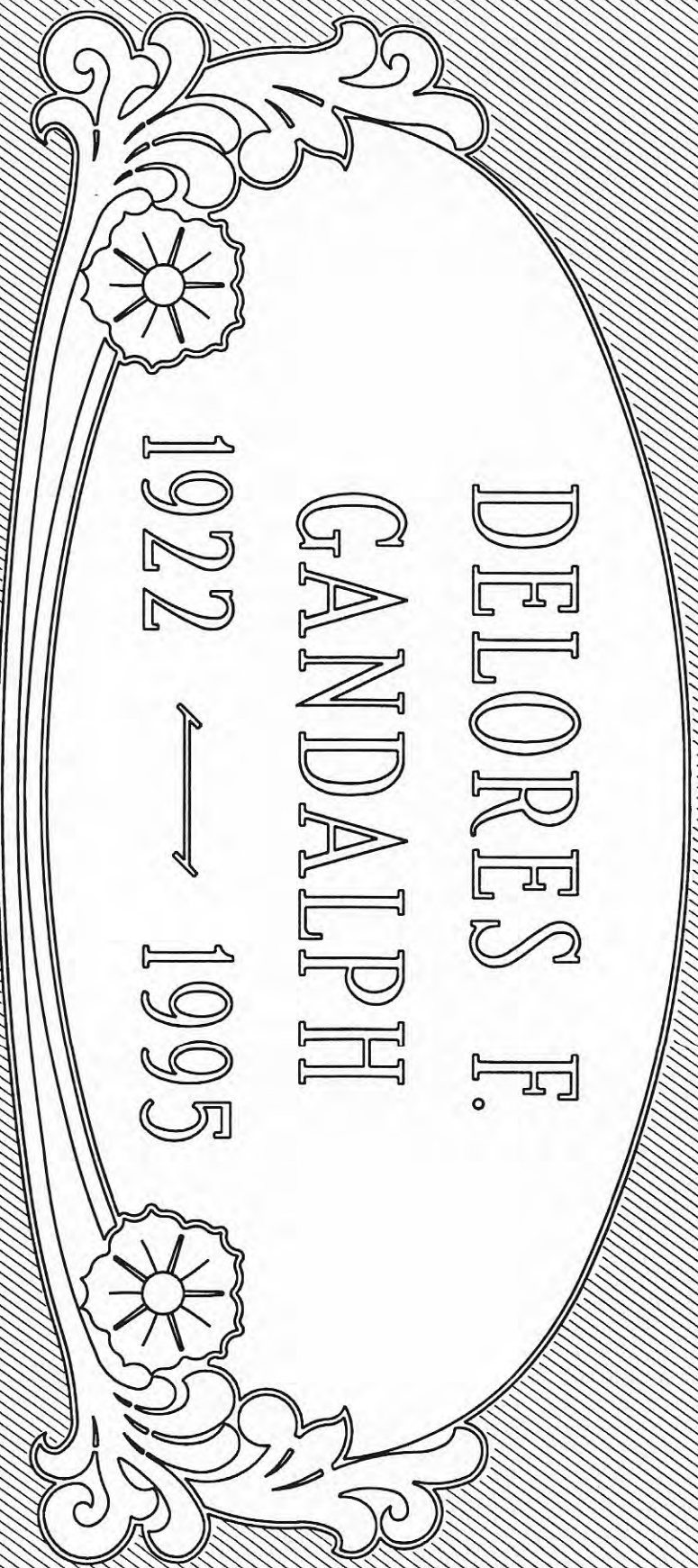

DELORES F.

GANDALPH

1922 — 1995

G78M2412



LEONARD G.

HAYMASTER

1912 — 1995



G79M2412



BAMBURG

1936 FRANK L. 1995

1938 TERRY D.

G80M2412

OUR BELOVED SON
DAVID RAY
COOPER
1992 → 1995

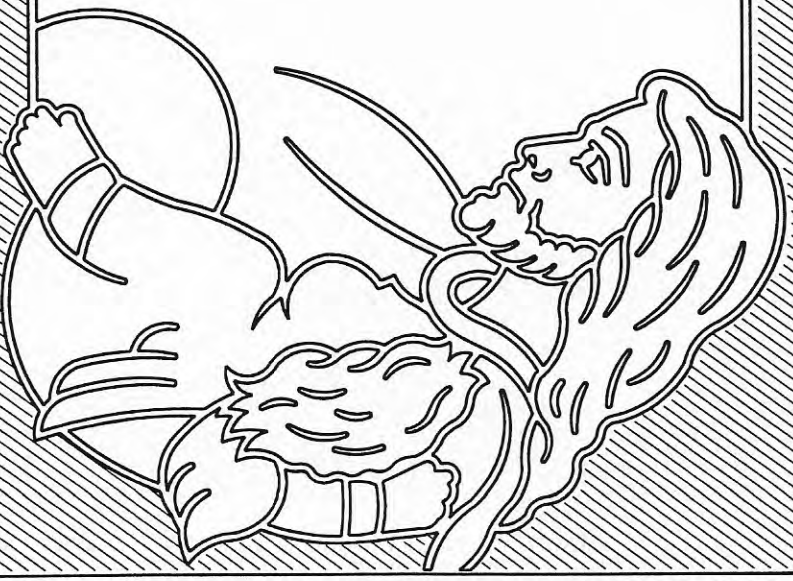

G81M1808



FLORENCE W.
CAMBERSON
1923 — 1995

G82M2412

JACOB N.
1923 - 1995

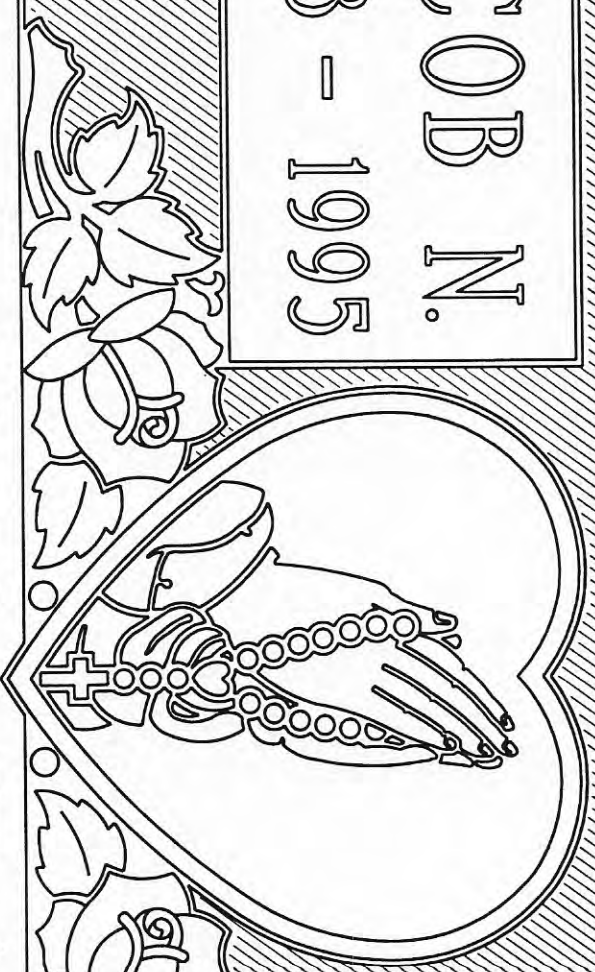

MARY T.
1925 -

MONIHAN

G83M2412

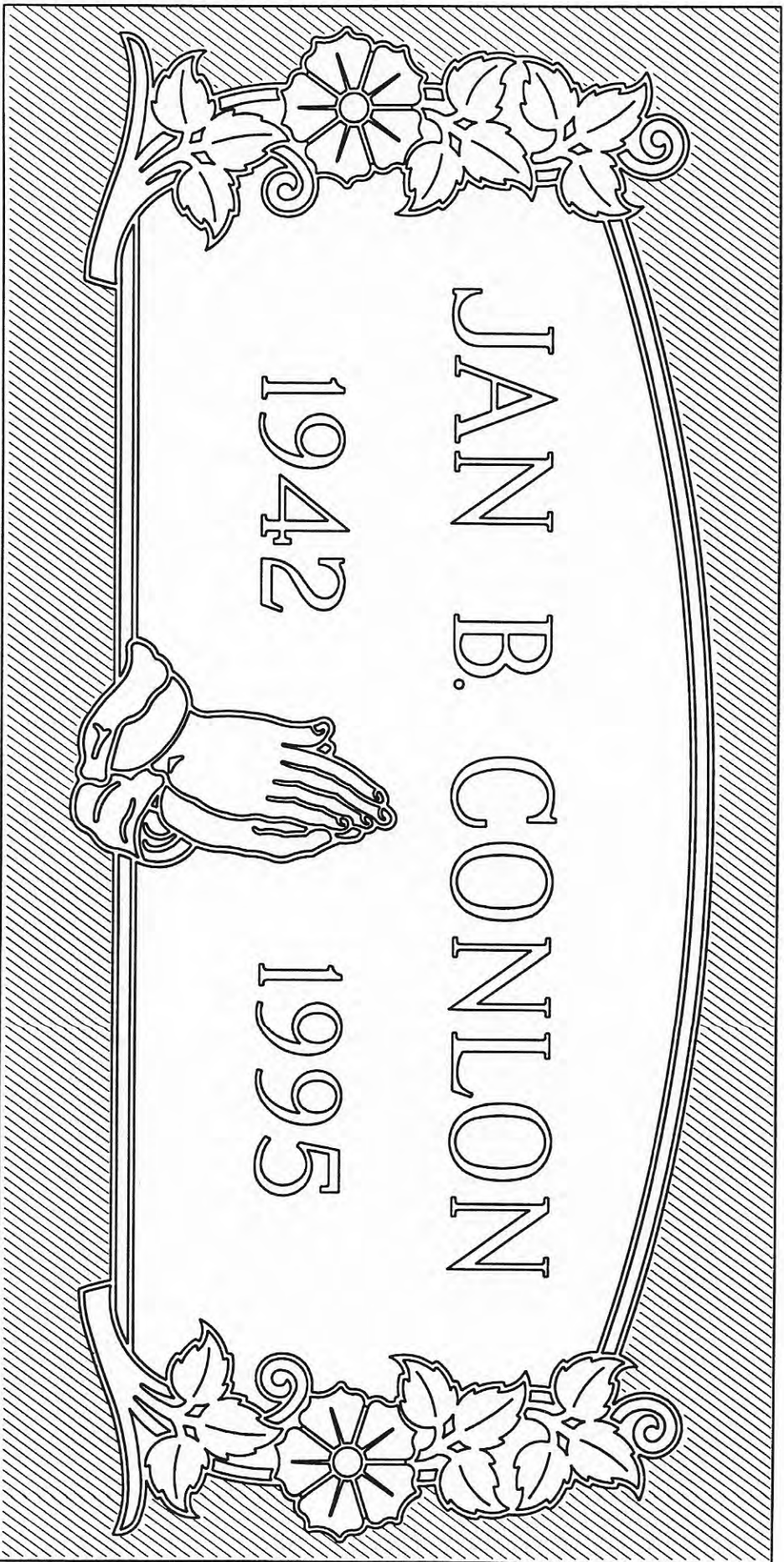

JAN B. CONLON

1942

1995



G84M2412

CENTERS

SARAH B.
1923 → 1995



MARTIN V.
1922 →

G85M2412



BELLOVED DAUGHTER
ANGELA LYNN
GROVETON
1993 — 1995

G86M2412

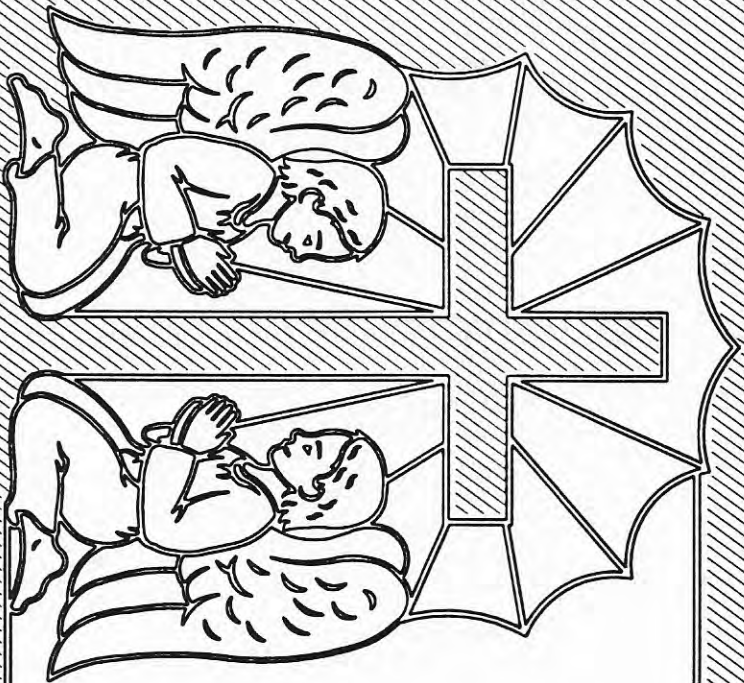

BELOVED SON
JAMES F.
OLSON
1985 — 1995

G87M2412

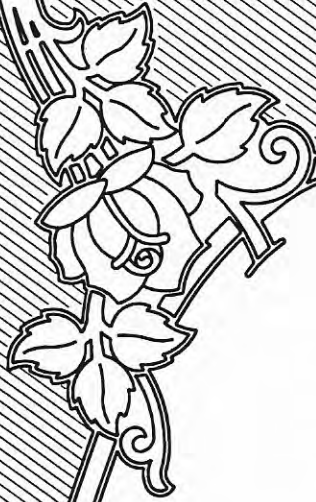

WALTERS

BARBARA S.

1930 → 1995



G88M3012

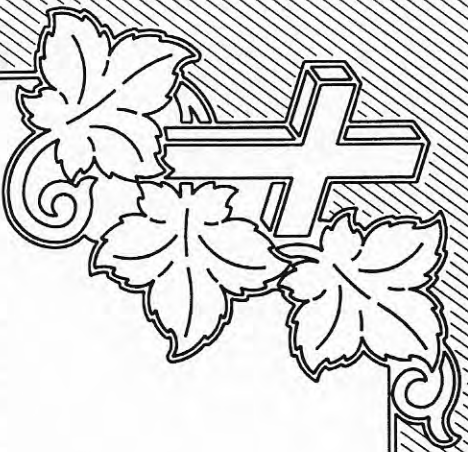

WALKER

JAMES T. WILMA

1918 — 1977 1920 — 1995

G89M2412

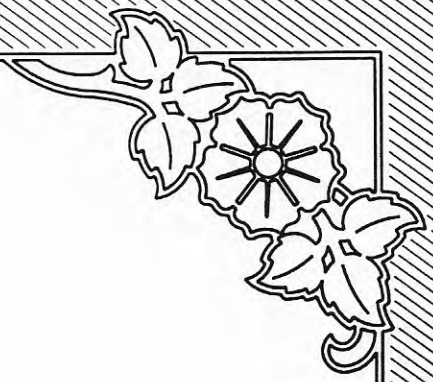

ROLAND T.

BASCOMB

1925 — 1995

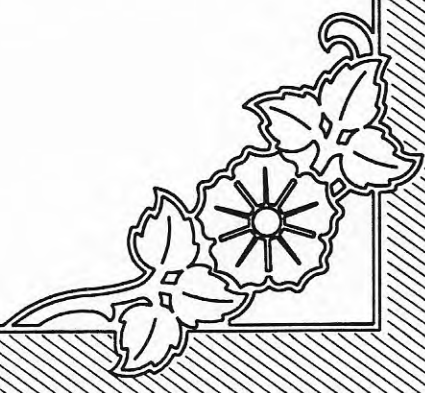

G90M2412

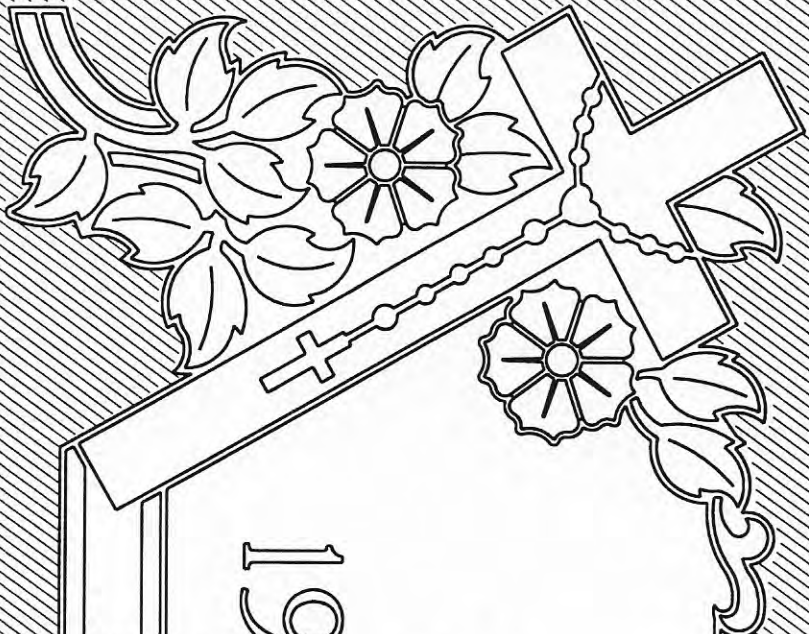

RANDALL
GUNTHER
1952 — 1994

FOREVER IN OUR HEARTS

G91M2412

SANDRA V.
TAYLOR

1942 — 1995

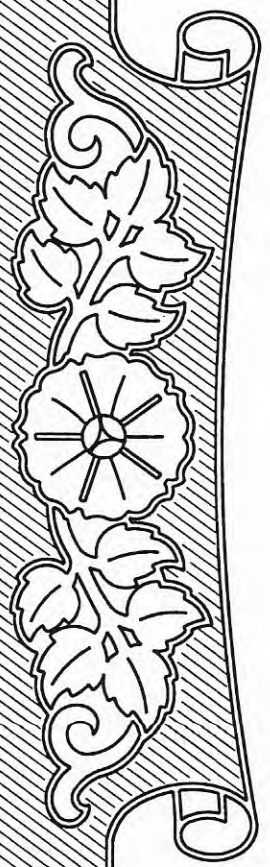

G92M2412



ALLAN M.
FLEAURREY
1933 — 1992

G93M2412



BELOVED MOTHER



MILDRED B. SUMNER

1933

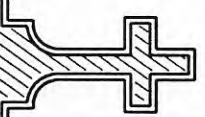

1994

G94M2412

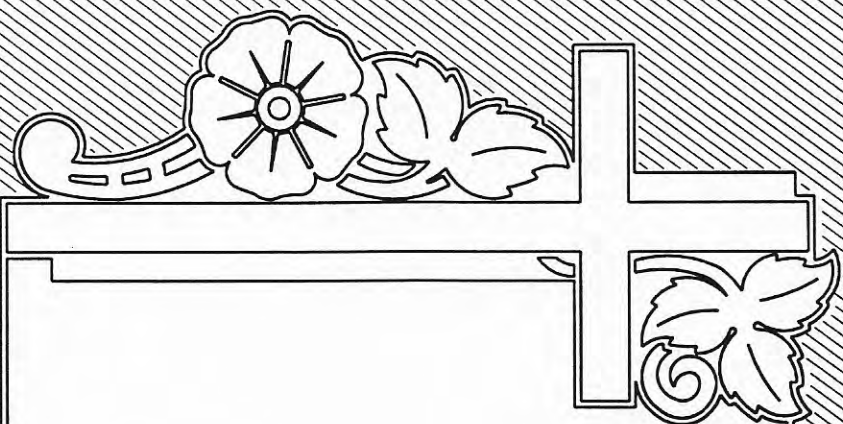

GERRY V.

BLOOMER

1954 — 1992

G95M2412

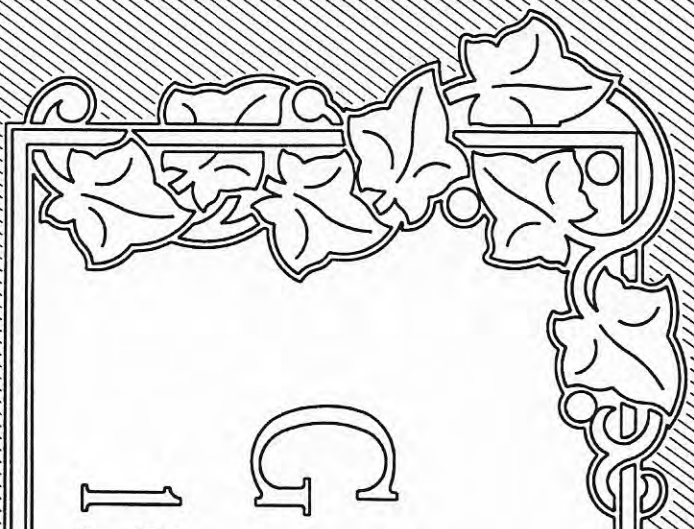

KARRA B.

GREENWOOD

1965 → 1995

G96M2412



OUR BELOVED SON

SCOTT MITCHELL

1993 — 1995



G97M2008

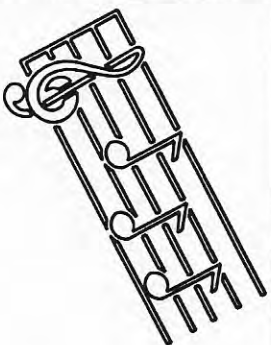

MICHAEL T.

POWERS

1934 — 1993

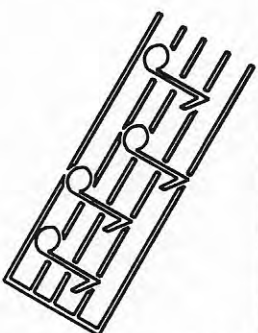

G98M2412

BRANDDON C.
MALLAY
1966 → 1995

G99M2412